

UNI-T®



Certificate No. 956661

UT262A/UT262C

Operating Manual



Phase Detector



P/N:110401104267X

CONTENT

Warning.....	1
I. Introduction.....	3
II. Electrical Symbols.....	4
III. Model.....	4
IV. Technical Specification.....	5
V. Instrument Structure.....	7
VI. Method of Operation.....	8
VII. Battery Replacement.....	11
VIII. Trouble shooting.....	13
IX. Assembly Details.....	14
X. Accessories.....	15

Warning

Thank you for purchasing our UT262A、 UT262C Non-contact Phase Detector, in order to better use of this product, be sure to:

----To read this user manual carefully.

----Comply strictly with safety rules and precautions set out in this manual.

◆ Pay special attention to safety under any circumstances while using the instrument.

◆ Take note of the label text and symbols on the panel and back of the instrument.

Check the instrument, lead wire and clamps, make sure no damage, no exposed and no break.

◆ Please don't touch an exposed wire in measurement.

◆ Keep the clamp clean and maintain regularly.

◆ Please don't place and store the instrument at the place with high temperature, humidity, moisture condensation and straight sunlight for a long time.

◆ Remove or replace the battery if you expect not to use the instrument for a long time.

◆ Take note of the polarity when replace the battery, don't replace batteries before move away the clamps from wires.

◆ The operation, demolition, calibration and maintenance of the instrument must be carried out by qualified personnel authorized to do so.

◆ The meter should be stopped from being used immediately and sealed if danger is brought up in case of continued use; only a competent body can be authorized to deal with it.

◆ “” in the manual is the safety warning sign, the contents of this manual must be followed for safe operation.

◆ “” and other safety signs, the contents of this manual must be followed for safe operation.





I. Introduction

UT262A、UT262C Non-contact Phase Detector breakthrough the traditional method of phase detection. The traditional method is to connect three exposed clips or probes to three bared live wires, so it need to disconnect the three phase wires. While UT262A、UT262C Non-contact Phase Detector adopts non-contact measurement, no need to disconnect wires, no need to touch high voltage bared live wires. With the three clamps clip on the insulation layer of three phase live wires, then the phase can be detected, meanwhile sound and light indicating positive or negative states.

UT262A、UT262C Non-contact Phase Detector also have the functions of live wire examination, power inspection, phase deficiency judgment, breakpoints finding, breakpoints positioning.

UT262A、UT262C Non-contact Phase Detector is a convenient and fast tool for phase detection, with clear display. It improves the safety of field testing, ensures the safety of operators, increase productivity.

II. Electrical Symbols

	Extremely dangerous! The operator must strictly abide by the safety rules; otherwise there is risk of electric shock, resulting in bodily injury or fatalities.
	Warning! Safety rules must be strictly abided by, otherwise personal injury or equipment damage may be caused.
	Alternate Current (AC)
	Direct Current (DC)
	Double Insulation

III. Model

Model	Diameter of wires can be clamped
UT262A	ø1.6mm-ø16mm
UT262C	ø10mm-ø40mm

IV. Technical Specification

1. **Function:** Phase detection (positive/negative), live wire examination, power inspection, phase deficiency judgment, breakpoints finding, breakpoints positioning.

2. **Power Supply:** 3V DC (R6P×2 manganese alloy batteries, continuously working for 150 hours)

3. **Performance-guarantee Range:** UT262A(AC70V-600V)/UT262C(AC70V-1000V), 40/70Hz (sine wave, continuously), static induction.

4. **Diameter of wires can be clamped:** ϕ 1.6mm- ϕ 16mm or ϕ 10mm- ϕ 40mm (optional)

5. Display:

【Positive Phase Sequence】

The four phase-sequence lamps blink in order (clockwise).

【Negative Phase Sequence】

The four phase-sequence lamps blink in order (counterclockwise).

【Line-voltage Indication】 R-S lamp, S-T lamp light up.

【Default Phase】 R-S lamp, S-T lamp is off.

6. Buzzer:

【Positive Phase Sequence】 The buzzer sounds intermittently.

【Negative Phase Sequence】 The buzzer sounds continuously.

7. **Power Indication:** Power ON lamp: lights up (Power ON), blinks (In using)

8. **Auto Power Off:** The power will be turned off automatically if the instrument remains idle for 5 minutes after the power is turned on.

9. **Dimension:** 70W×75H×30D (mm)

10. **Cable Length:** 0.5m

11. **Weight :** 200g

12. **Working Temperature and Humidity:** -10℃-55℃; below 80%Rh

13. **Storage Temperature and Humidity:** -20℃-60℃; below 90%Rh

14. **Maximum Rated Voltage:** UT262A(AC 600V)/UT262C(AC 1000V)

15. **Dielectric Strength:** 5.4kVrms

16. **Maximum Rated Power:** 300Mva

17. **Safety Specifications:** EN61010-1: 2001, EN61010-031: 2002, 2 class of pollution, CAT III (600V), transient over voltage 6000V.

V. Instrument Structure

1. Operation indicating panel
2. Lead Wire
3. Instrument body
4. Clamps
5. R-S, S-T indicator lamp
6. Phase sequence indicator lamp (4 lamps)
7. Safety specification symbol
8. Power on indicator lamp
9. ON power key
10. Product name
11. OFF power key

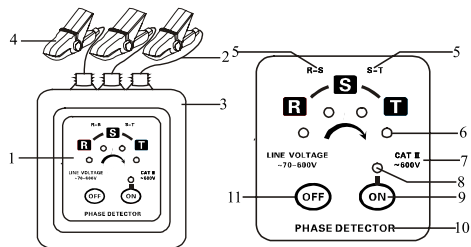

VI. Method of Operation

1. Phase sequence detection

⚠ Danger! High voltage! Please pay attention to safety!

- (1). Connection Clamp three phase wires with the three clamps respectively and arbitrarily (Shown in Fig-1).
- (2). Put the wires at the position marked with ▼ (Shown in Fig-2)

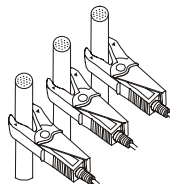

Fig-1

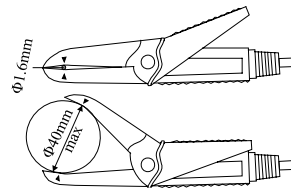

Fig-2

(3). Press the red ON power key, the power indicator lamp lights up. If the lamp can't light up, maybe the battery in low power or check the instrument, in that case, please change the batteries or repair the instrument.

(4). If the 4 phase sequence indicator lamps light up in clockwise order, and the buzzer sounds intermittently, so it is positive phase sequence R-S-T (Shown in Fig-3). If the 4 phase sequence indicator lamps light up in counterclockwise order, and the buzzer sounds continuously, so it is negative phase sequence T-S-R (Shown in Fig-4).

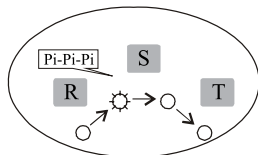

Fig-1 Positive Phase Sequence

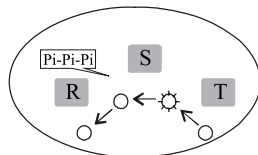

Fig-2 Negative Phase Sequence

(5). Press white OFF power key, the power will be turned off automatically if the instrument remains idle for 5 minutes after the power is turned on, to reduce power consumption.

2. Live wire examination, power inspection

⚠ Danger! High voltage! Please pay attention to safety!

(1). Clamp one wire with any one clamp, if it is an electrified wire (AC70-1000V), then R-S or S-T lamps will light up. In this way to check whether the wire is electrified.

(2). Clamps and lamps corresponding table:

Clamp used	Lamp to light up
R(Yellow)	R-S lamp only
S(Green)	R-S lamp and S-T lamp
T(Red)	S-T lamp only

3. Phase deficiency judgment, breakpoints finding, breakpoints positioning

⚠ Danger! High voltage! Please pay attention to safety!

(1). Clamp there phase wires with one clamp in turn, if there is phase deficiency,

R-S or S-T lamps won't light up.

(2). Clamp one wire with any one clamp and move the clamp along the wire, if the R-S or S-T lamps lights off, it means the section wire before this point has a break. Shorten the range of detection can find out the breakpoints accurately. It is a convenient and safety method for wire maintenance.

Note:

This function is very suitable for maintaining the circuit fault in the wire, safe and fast!

VII. Battery Replacement

Pay attention to the polarity of batteries!

1. Make sure the clamps have moved away from wires, don't replace the batteries in measurement.
2. Turn OFF the power. (Figure A)
3. Loosen the screw, and then remove the battery cover. (Figure B)
4. Replace the batteries with new ones, notice the polarity. (Figure C)

5. Put the battery cover back in place, and tighten the screw. (Figure D)

6. Turn ON the power to check whether the batteries are successfully replaced, repeat step 2 if it doesn't work.



Figure A



Figure B

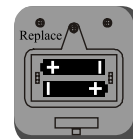

Figure C

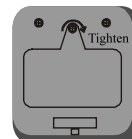
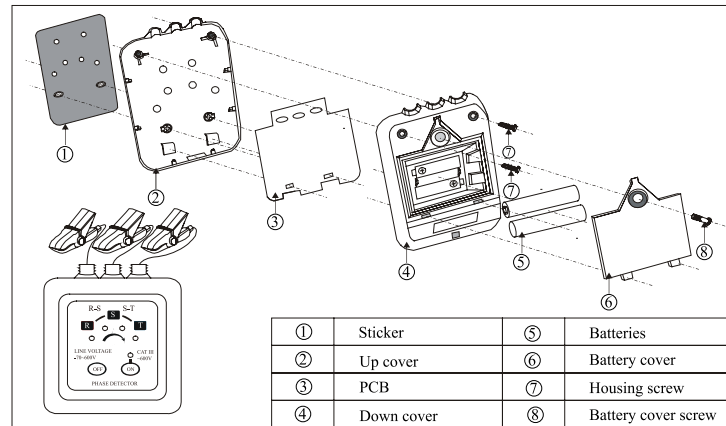

Figure D

VIII. Trouble shooting

Symptoms	Possible Causes	Remedies
Can't power on (LED power indicator lamp is off, without any display)	No batteries	Set the batteries
	Wrong battery type	Replace with right type
	Insufficient capacity of battery	Replace the batteries
	Faulty battery polarity	Install batteries in correct polarity
	Poor contact of battery contacts	Replace the battery contacts
	Battery cover not completely covered	Cover it again
	Defect of circuit component	Repair or replace the PCB
LED dim display	Insufficient capacity of battery	Replace the batteries
Incapable of measurement	The three phase wires are not electrified	Not belong to instrument faults
	Failed to clamp the wire	Clamp again refer the manual
	Lead wire break	Change the lead wire
	Defect of circuit component	Repair or replace the PCB

IX. Assembly Details



①	Sticker	⑤	Batteries
②	Up cover	⑥	Battery cover
③	PCB	⑦	Housing screw
④	Down cover	⑧	Battery cover screw

X. Accessories

Main Unit	1 piece
Box	1 piece
Strap	1 piece
5# manganese alloy batteries (R6P)	2 piece
Manual	1 copy
Guarantee Card	1 copy
Certification	1 copy

Manufacturer:
 Uni-Trend Technology (China) Limited
 No 6, Gong Ye Bei 1st Road
 Songshan Lake National High-Tech Industrial
 Development Zone, Dongguan City
 Guangdong Province
 China
 Postal Code: 523 808

Headquarters:
 Uni-Trend Group Limited
 Rm901, 9/F, Nanyang Plaza
 57 Hung To Road
 Kwun Tong
 Kowloon, Hong Kong
 Tel: (852) 2950 9168
 Fax: (852) 2950 9303
 Email: info@uni-trend.com
<http://www.uni-trend.com>