

Varistor 48...127 V AC, 70...150 V DC Surge suppressor for plugging onto contactors Size S00



Figure similar

General technical data:		
Product brand name		SIRIUS
Product designation		surge suppressor
Size of contactor		S00
Design of the surge suppressor		with varistor
Control circuit/ Control:		
Type of voltage of the control supply voltage		AC/DC
Control supply voltage frequency		
• 1 rated value	Hz	50
• 2 rated value	Hz	60
Control supply voltage 1		
• at DC		
— Initial rated value	V	70
— Final rated value	V	150
• at AC		
— at 50 Hz Initial rated value	V	48
— at 50 Hz Final rated value	V	127





- at 60 Hz Final rated value
- at 60 Hz Initial rated value

V	127
V	48

Installation/ mounting/ dimensions:

Mounting position	any
Mounting type	clip-on

Certificates/ approvals:

General Product Approval	Functional Safety/Safety of Machinery	Declaration of Conformity	Test Certificates
 CSA  UR  EAC	Type Examination Certificate	 EG-Konf.	Special Test Certificate

Shipping Approval



other

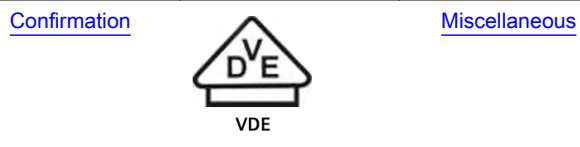

Further information

- Information- and Downloadcenter (Catalogs, Brochures,...)**
<http://www.siemens.com/industrial-controls/catalogs>
- Industry Mall (Online ordering system)**
<http://www.siemens.com/industrymall>
- Cax online generator**
<http://support.automation.siemens.com/WW/CAXorder/default.aspx?lang=en&mlfb=3RT1916-1BC00>
- Service&Support (Manuals, Certificates, Characteristics, FAQs,...)**
<https://support.industry.siemens.com/cs/ww/en/ps/3RT1916-1BC00>
- Image database (product images, 2D dimension drawings, 3D models, device circuit diagrams, EPLAN macros, ...)**
http://www.automation.siemens.com/bilddb/cax_de.aspx?mlfb=3RT1916-1BC00&lang=en

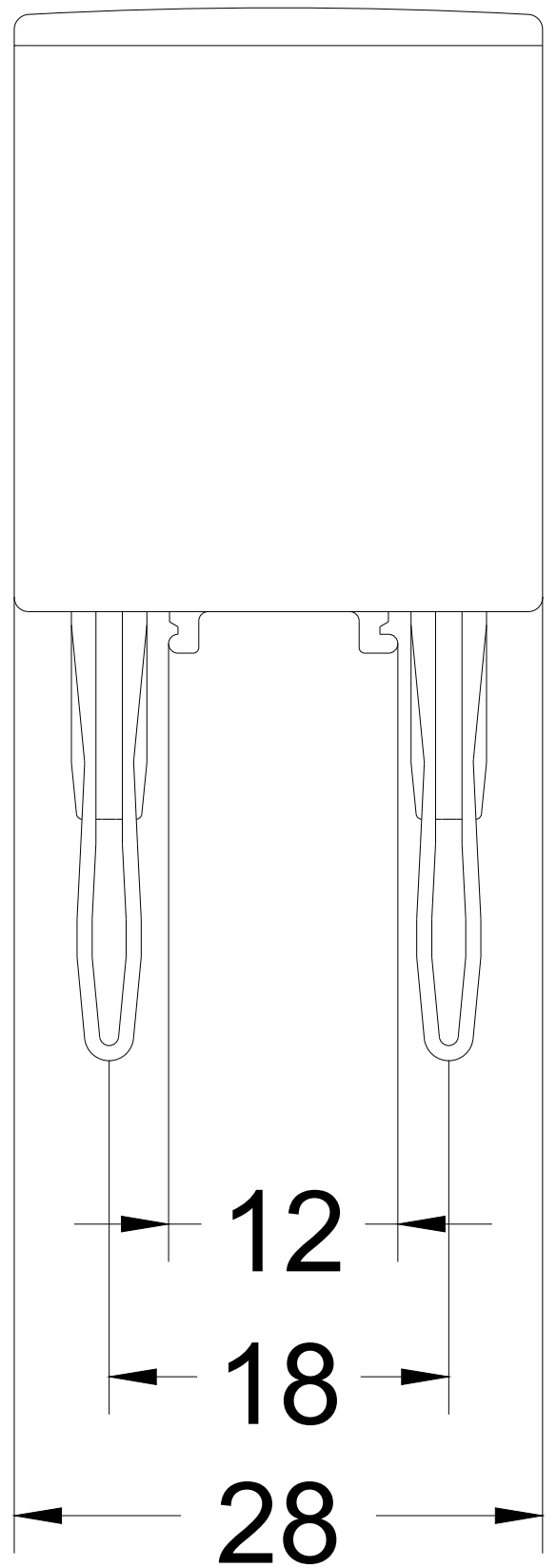
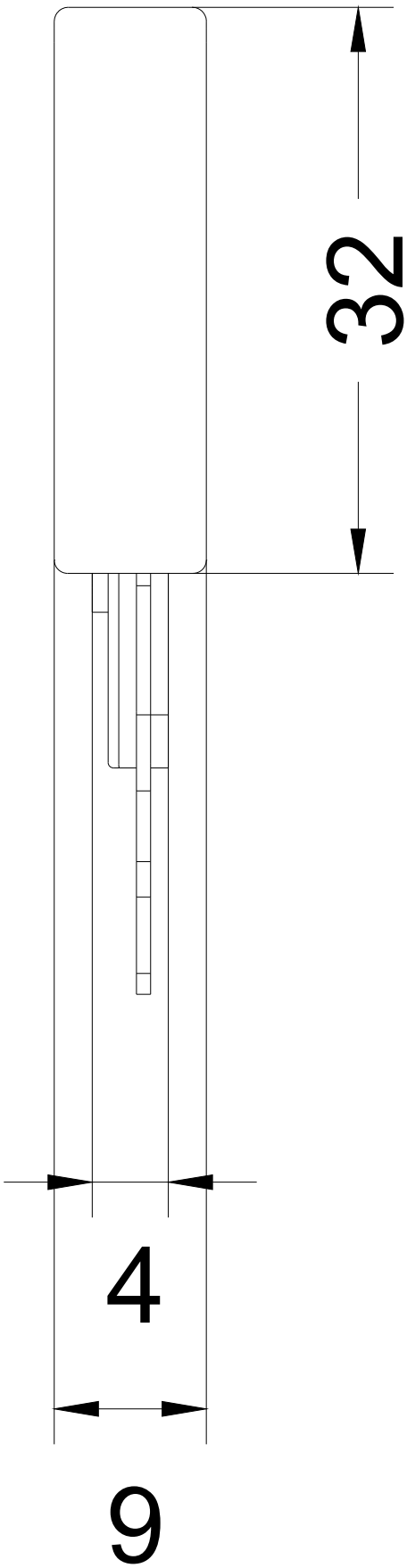

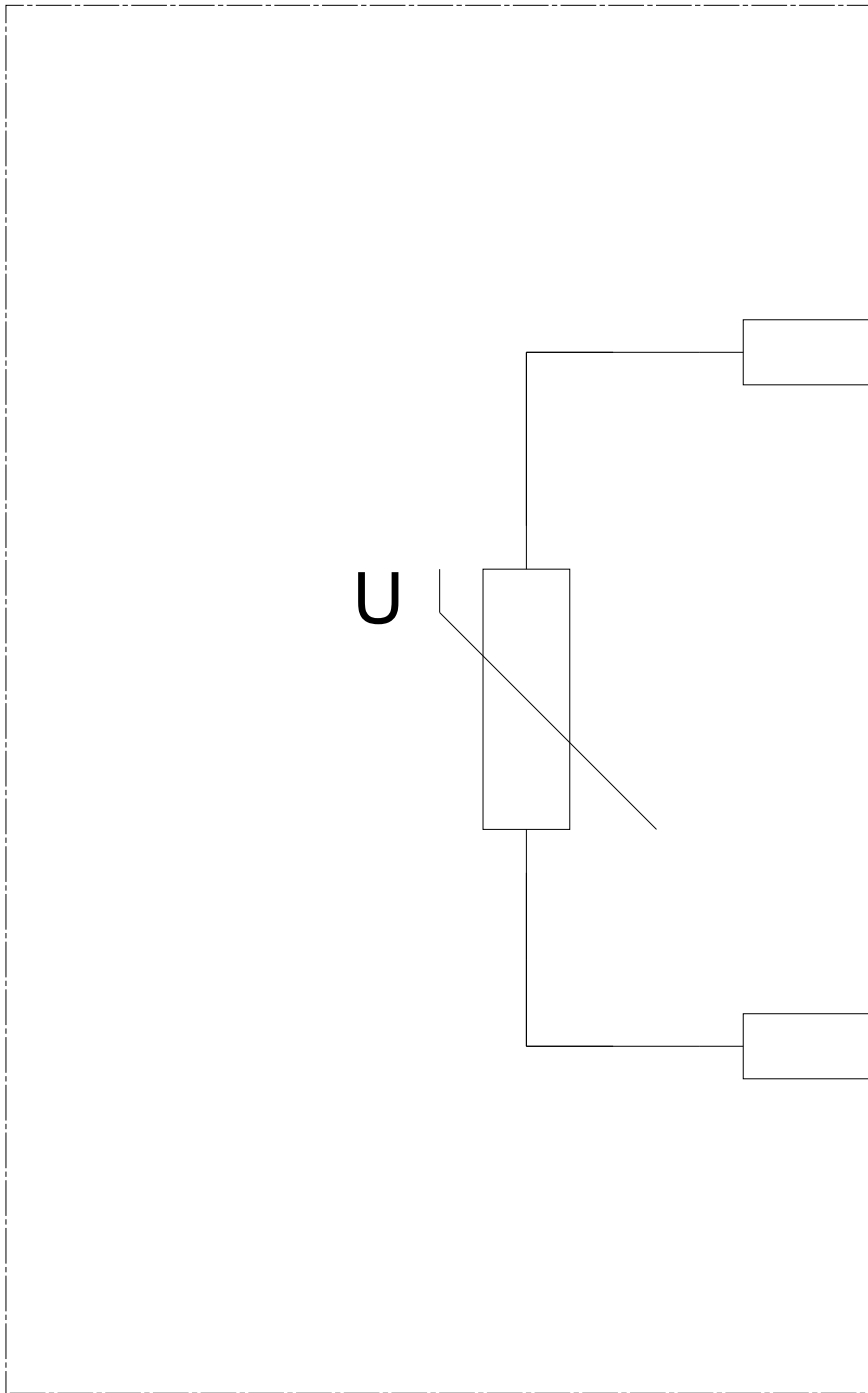

last modified:

04/29/2018