



Circuit-breaker, 3p, 630A

Part no. NZMN3-AE630
Article no. 259115

Delivery programme

Product range			Circuit-breaker
Protective function			System and cable protection
Standard/Approval			IEC
Installation type			Fixed
Release system			Electronic release
Construction size			NZM3
Description			R.m.s. value measurement and "thermal memory"
Number of poles			3 pole
Standard equipment			Screw connection





Switching capacity

400/415 V 50/60 Hz	I_{cu}	kA	50
--------------------	----------	----	----

Rated current = rated uninterrupted current

Rated current = rated uninterrupted current	$I_n = I_u$	A	630
---	-------------	---	-----

Setting range

Overload trip			
	I_r	A	315 - 630
Short-circuit releases			
			
Non-delayed	$I_i = I_n \times \dots$		2 - 8
			
Short-circuit releases	I_{rm}	A	630 - 5040
			

Technical data

General

Standards			IEC/EN 60947
Protection against direct contact			Finger and back of hand proof to VDE 0106 Part 100
Climatic proofing			Damp heat, constant, to IEC 60068-2-78 Damp heat, cyclic, to IEC 60068-2-30
Ambient temperature			
Ambient temperature, storage		°C	- 40 - + 80
Operation		°C	-25 - +70
Mechanical shock resistance (10 ms half-sinusoidal shock) according to IEC 60068-2-27		g	20 (half-sinusoidal shock 20 ms)
Safe isolation to EN 61140			
Between auxiliary contacts and main contacts		V AC	500
between the auxiliary contacts		V AC	300
Weight		kg	6.34
Mounting position			Vertical and 90° in all directions



With residual-current release XFI:

- NZM1, N1, NZM2, N2: vertical and 90° in all directions
- with plug-in adapter elements
- NZM1, N1, NZM2, N2: vertical, 90° right/left
- with withdrawable unit:
- NZM3, N3: vertical, 90° left
- NZM4, N4: vertical
- with remote operator:
- NZM2, N(S)2, NZM3, N(S)3, NZM4, N(S)4: vertical and 90° in all directions

Direction of incoming supply		as required
Degree of protection		
Device		In the operating controls area: IP20 (basic degree of protection)
Enclosures		With insulating surround: IP40 With door coupling rotary handle: IP66
Terminations		Tunnel terminal: IP10 Phase isolator and strip terminal: IP00
Other technical data (sheet catalogue)		Weight Temperature dependency, Derating Effective power loss

Circuit-breakers

Rated current – rated uninterrupted current	$I_n = I_u$	A	630
Rated surge voltage invariability	U_{imp}		
Main contacts		V	8000
Auxiliary contacts		V	6000
Rated operational voltage	U_e	V AC	690
Overvoltage category/pollution degree			III/3
Rated insulation voltage	U_i	V	1000
Use in unearthed supply systems		V	\leq 690

Switching capacity

Rated short-circuit making capacity	I_{cm}		
240 V	I_{cm}	kA	187
400/415 V	I_{cm}	kA	105
440 V 50/60 Hz	I_{cm}	kA	74
525 V 50/60 Hz	I_{cm}	kA	53
690 V 50/60 Hz	I_c	kA	40
Rated short-circuit breaking capacity I_{cn}	I_{cn}		
Icu to IEC/EN 60947 test cycle O-t-CO	I_{cu}	kA	
240 V 50/60 Hz	I_{cu}	kA	85
400/415 V 50/60 Hz	I_{cu}	kA	50
440 V 50/60 Hz	I_{cu}	kA	35
525 V 50/60 Hz	I_{cu}	kA	25
690 V 50/60 Hz	I_{cu}	kA	20
Ics to IEC/EN 60947 test cycle O-t-CO-t-CO	I_{cs}	kA	
240 V 50/60 Hz	I_{cs}	kA	85
400/415 V 50/60 Hz	I_{cs}	kA	50
440 V 50/60 Hz	I_{cs}	kA	35
525 V 50/60 Hz	I_{cs}	kA	13
690 V 50/60 Hz	I_{cs}	kA	5
			Maximum back-up fuse, if the expected short-circuit currents at the installation location exceed the switching capacity of the circuit-breaker.
Rated short-time withstand current			
t = 0.3 s	I_{cw}	kA	3.3
t = 1 s	I_{cw}	kA	3.3
Utilization category to IEC/EN 60947-2			A
Rated making and breaking capacity			
Rated operational current	I_e	A	

AC-1			
380 V 400 V	I _e	A	630
415 V	I _e	A	630
690 V	I _e	A	630
AC--3			
380 V 400 V	I _e	A	450
415 V	I _e	A	450
660 V 690 V	I _e	A	450
Lifespan, mechanical(of which max. 50 % trip by shunt/undervoltage release)	Operations		15000
Lifespan, electrical			
AC-1			
400 V 50/60 Hz	Operations		5000
415 V 50/60 Hz	Operations		5000
690 V 50/60 Hz	Operations		3000
AC--3			
400 V 50/60 Hz	Operations		2000
415 V 50/60 Hz	Operations		2000
690 V 50/60 Hz	Operations		2000
Max. operating frequency		Ops/h	60
Current heat losses per pole at I _u are based on the maximum rated operational current of the frame size.		W	40
			For current heat loss per pole the specification refers to the maximum rated operational current of the frame size.
Total downtime in a short-circuit		ms	< 10

Terminal capacity

Standard equipment			Screw connection
Overview			Basic equipment Box terminal ● - - - Screw connection - ● ● ● Accessories Box terminal - ● ● - Screw connection ● - - ● Tunnel terminal ● ● ● ● Connection on rear ● ● ● ● Flat conductor terminal - - - ●
Round copper conductor			
Box terminal			
Solid		mm ²	2 x 16
Stranded		mm ²	1 x (35 - 240) 2 x (25 - 120)
Tunnel terminal			
Stranded		mm ²	
Stranded		mm ²	1 x (25 - 185)
Double hole fitting		mm ²	1 x (50 - 240) 2 x (50 - 240)
Bolt terminal and rear-side connection			
Direct on the switch			
Solid		mm ²	1 x 16 2 x 16
Stranded		mm ²	1 x (25 - 240) 2 x (25 - 240)
Connection width extension		mm ²	
Connection width extension		mm ²	2 x 300
Al conductors, Cu cable			

Solid		mm ²	1 x 16
Stranded		mm ²	
Stranded		mm ²	1 x (25 - 185)
Double hole fitting		mm ²	1 x (50 - 240) 2 x (50 - 240)
Bolt terminal and rear-side connection			
Flat copper strip, with holes	min.	mm	6 x 16 x 0.8
Flat copper strip, with holes	max.	mm	10 x 32 x 1.0 + 5 x 32 x 1.0
Connection width extension		mm	(2 x) 10 x 50 x 1.0
Cu strip (number of segments x width x segment thickness)			
Box terminal			
	min.	mm	6 x 16 x 0.8
	max.	mm	10 x 24 x 1.0 + 5 x 24 x 1.0 (2 x) 8 x 24 x 1.0
Bolt terminal and rear-side connection			
Flat copper strip, with holes	min.	mm	6 x 16 x 0.8
Flat copper strip, with holes	max.	mm	10 x 32 x 1.0 + 5 x 32 x 1.0
Connection width extension		mm	(2 x) 10 x 50 x 1.0
Copper busbar (width x thickness)		mm	
Bolt terminal and rear-side connection			
Screw connection			M10
Direct on the switch			
	min.	mm	20 x 5
	max.	mm	30 x 10 + 30 x 5
Connection width extension		mm	
Connection width extension	max.	mm	2 x (10 x 50)
Control cables			
		mm ²	1 x (0.75 - 2.5) 2 x (0.75 - 1.5)

Design verification as per IEC/EN 61439

Technical data for design verification			
Rated operational current for specified heat dissipation	I _n	A	630
Equipment heat dissipation, current-dependent	P _{vid}	W	119.07
Operating ambient temperature min.		°C	-25
Operating ambient temperature max.		°C	70
IEC/EN 61439 design verification			
10.2 Strength of materials and parts			
10.2.2 Corrosion resistance			Meets the product standard's requirements.
10.2.3.1 Verification of thermal stability of enclosures			Meets the product standard's requirements.
10.2.3.2 Verification of resistance of insulating materials to normal heat			Meets the product standard's requirements.
10.2.3.3 Verification of resistance of insulating materials to abnormal heat and fire due to internal electric effects			Meets the product standard's requirements.
10.2.4 Resistance to ultra-violet (UV) radiation			Meets the product standard's requirements.
10.2.5 Lifting			Does not apply, since the entire switchgear needs to be evaluated.
10.2.6 Mechanical impact			Does not apply, since the entire switchgear needs to be evaluated.
10.2.7 Inscriptions			Meets the product standard's requirements.
10.3 Degree of protection of ASSEMBLIES			Does not apply, since the entire switchgear needs to be evaluated.
10.4 Clearances and creepage distances			Meets the product standard's requirements.
10.5 Protection against electric shock			Does not apply, since the entire switchgear needs to be evaluated.
10.6 Incorporation of switching devices and components			Does not apply, since the entire switchgear needs to be evaluated.
10.7 Internal electrical circuits and connections			Is the panel builder's responsibility.
10.8 Connections for external conductors			Is the panel builder's responsibility.
10.9 Insulation properties			

10.9.2 Power-frequency electric strength		Is the panel builder's responsibility.
10.9.3 Impulse withstand voltage		Is the panel builder's responsibility.
10.9.4 Testing of enclosures made of insulating material		Is the panel builder's responsibility.
10.10 Temperature rise		The panel builder is responsible for the temperature rise calculation. Eaton will provide heat dissipation data for the devices.
10.11 Short-circuit rating		Is the panel builder's responsibility. The specifications for the switchgear must be observed.
10.12 Electromagnetic compatibility		Is the panel builder's responsibility. The specifications for the switchgear must be observed.
10.13 Mechanical function		The device meets the requirements, provided the information in the instruction leaflet (IL) is observed.

Technical data ETIM 6.0

Low-voltage industrial components (EG000017) / Power circuit-breaker for trafo/generator/installation prot. (EC000228)		
Electric engineering, automation, process control engineering / Low-voltage switch technology / Circuit breaker (LV < 1 kV) / Circuit breaker for power transformer, generator and system protection (ecI@ss8.1-27-37-04-09 [AJZ716010])		
Rated permanent current I _u	A	630
Rated voltage	V	690 - 690
Rated short-circuit breaking capacity I _{cu} at 400 V, 50 Hz	kA	55
Overload release current setting	A	315 - 630
Adjustment range short-term delayed short-circuit release	A	0 - 0
Adjustment range undelayed short-circuit release	A	1260 - 5040
Integrated earth fault protection		No
Type of electrical connection of main circuit		Screw connection
Device construction		Built-in device fixed built-in technique
Suitable for DIN rail (top hat rail) mounting		No
DIN rail (top hat rail) mounting optional		No
Number of auxiliary contacts as normally closed contact		0
Number of auxiliary contacts as normally open contact		0
Number of auxiliary contacts as change-over contact		0
Switched-off indicator available		No
With under voltage release		No
Number of poles		3
Position of connection for main current circuit		Front side
Type of control element		Rocker lever
Complete device with protection unit		Yes
Motor drive integrated		No
Motor drive optional		Yes
Degree of protection (IP)		IP20

Characteristics

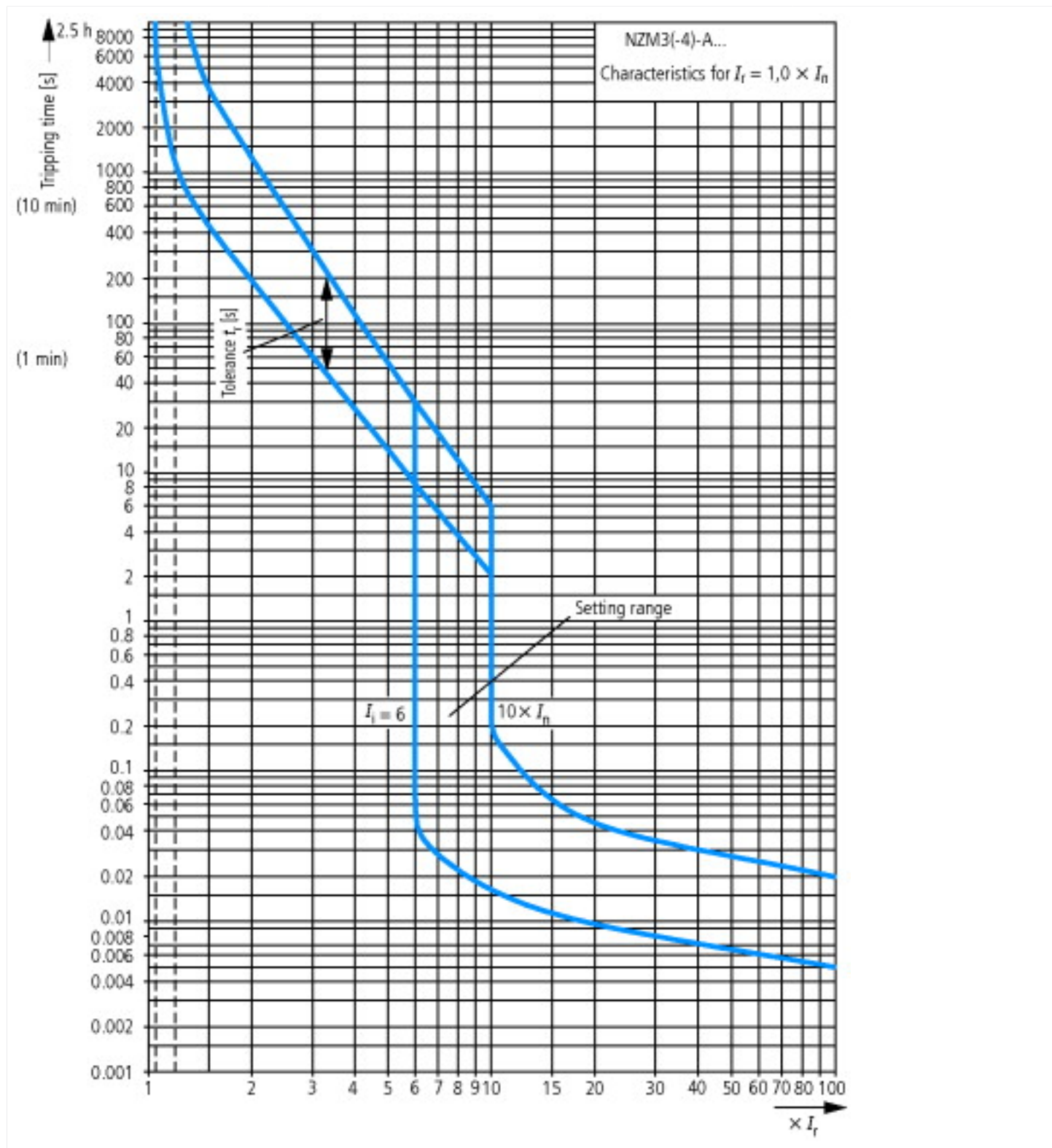

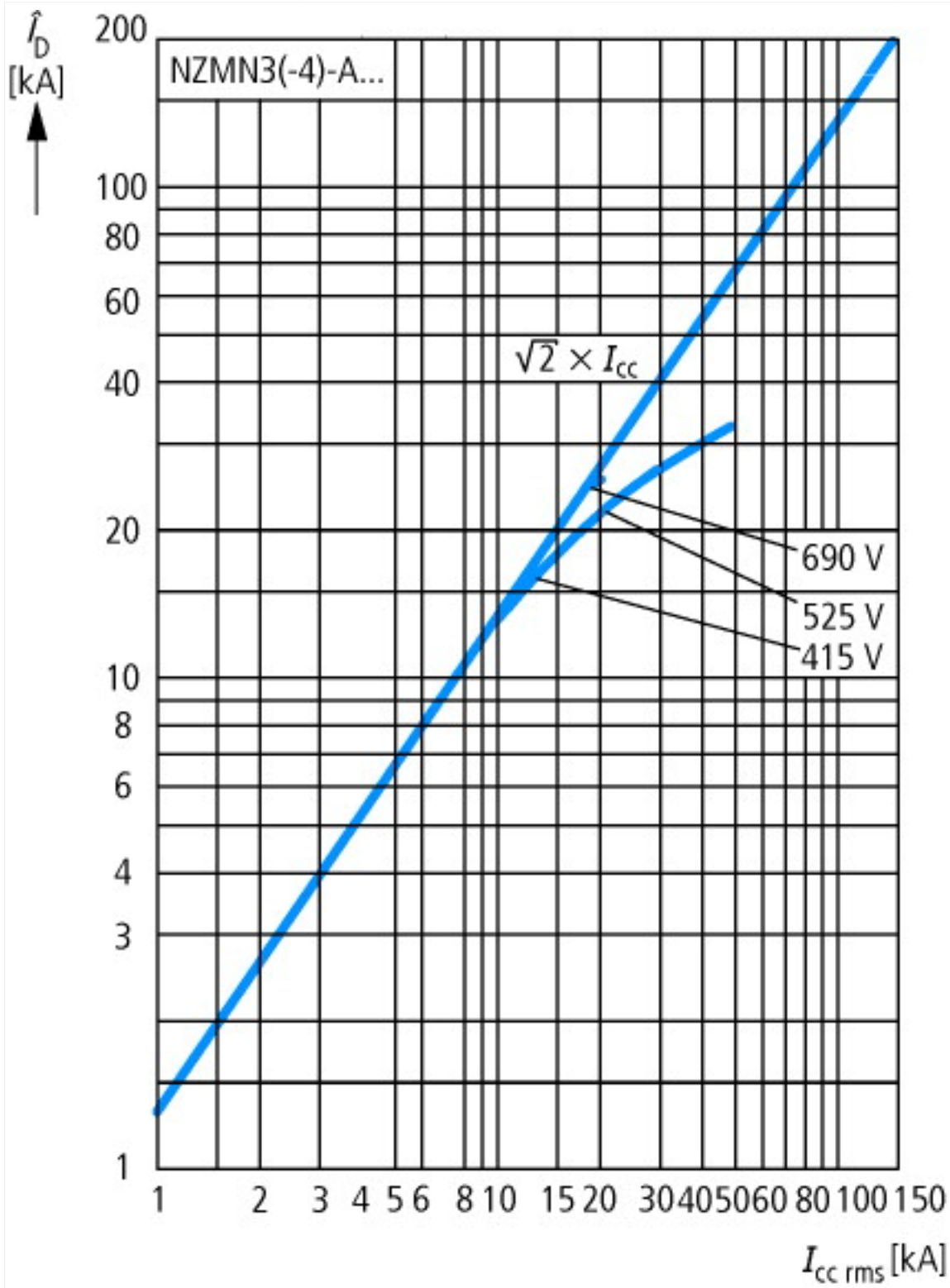

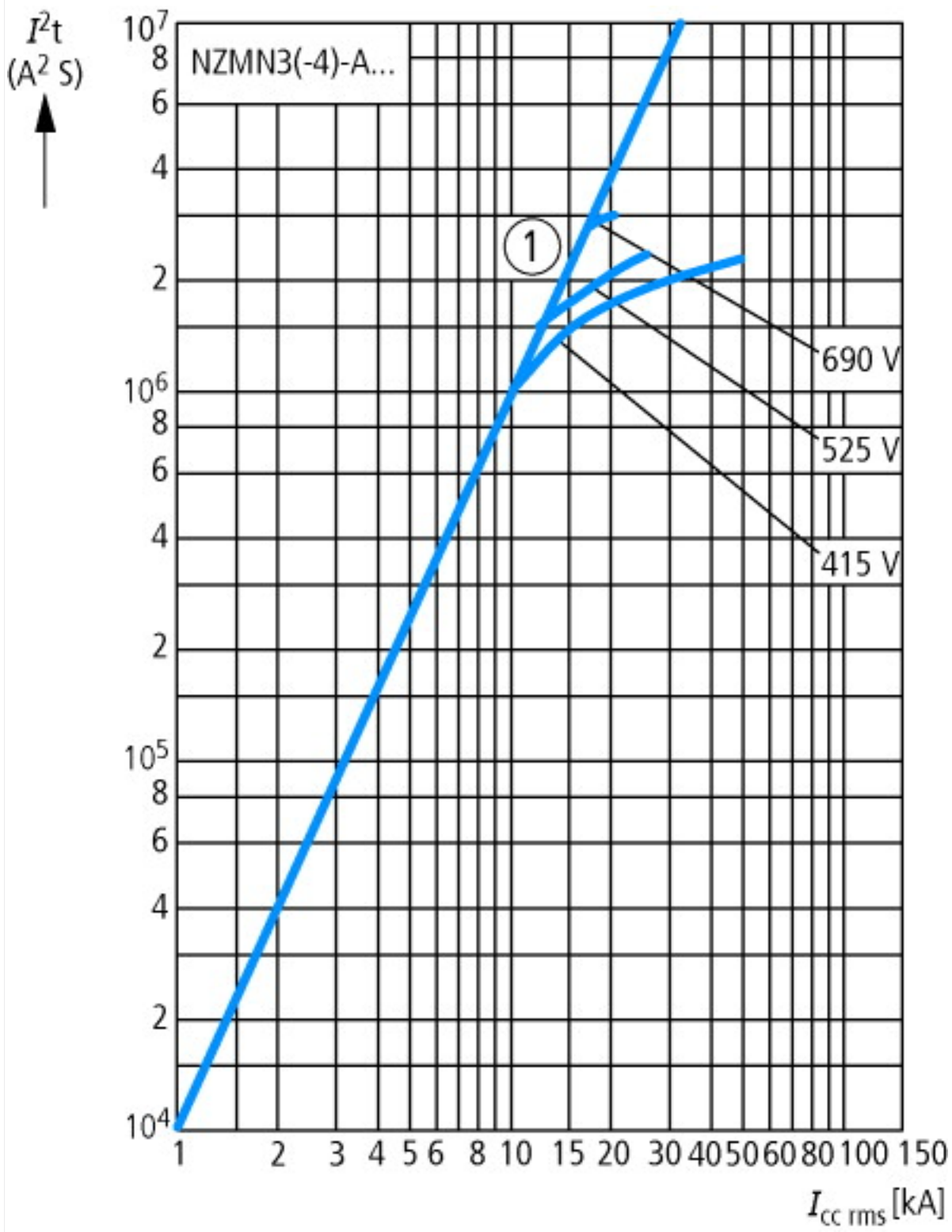

Dimensions

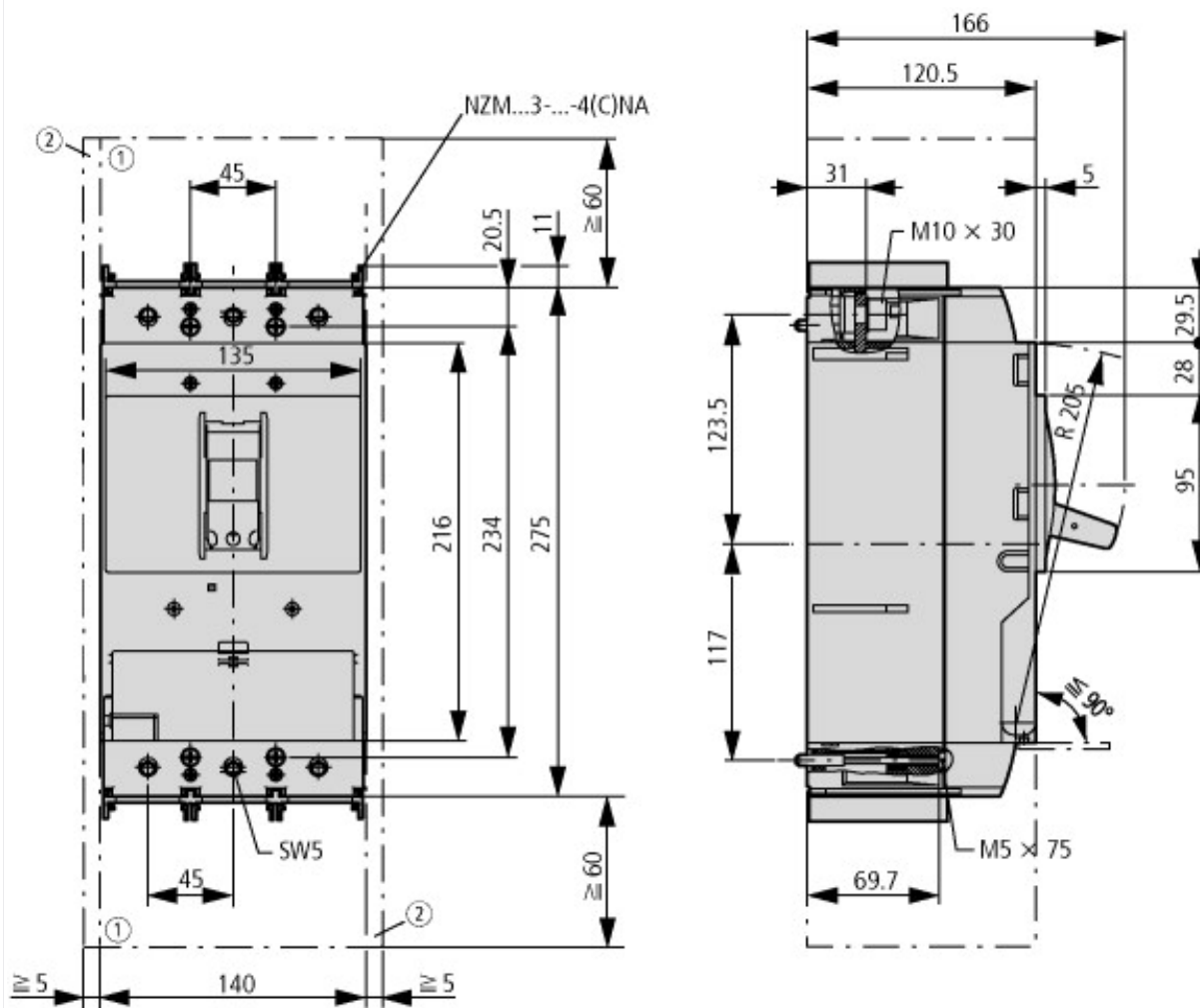

- ① Blow out area, minimum clearance to adjacent parts
- ② Minimum clearance to adjacent parts

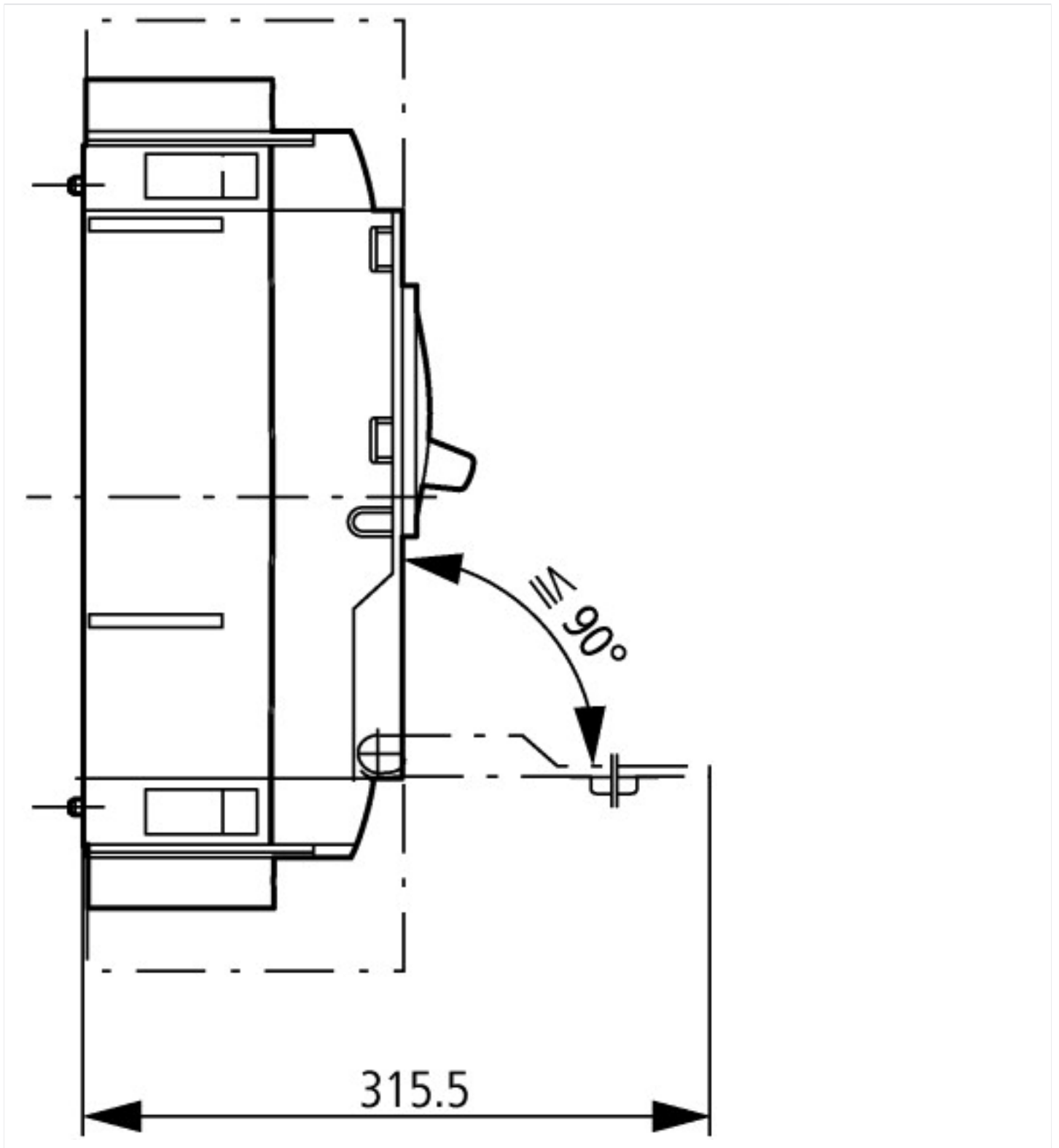

Additional product information (links)

IL01208009Z (AWA1230-1992) Circuit-Breaker, basic unit

IL01208009Z (AWA1230-1992) Circuit-Breaker, basic unit ftp://ftp.moeller.net/DOCUMENTATION/AWA_INSTRUCTIONS/IL01208009Z2014_07.pdf

Weight <http://ecat.moeller.net/flip-cat/?edition=HPLEN&startpage=17.171>

Temperature dependency, Derating <http://ecat.moeller.net/flip-cat/?edition=HPLEN&startpage=17.172>

Effective power loss <http://ecat.moeller.net/flip-cat/?edition=HPLEN&startpage=17.174>

Setting-Specific Representation of Tripping Characteristics and Competent Assessment of their Interaction http://www.moeller.net/binary/ver_techpapers/ver943en.pdf

Busbar Component Adapters for modern Industrial control panels http://www.moeller.net/binary/ver_techpapers/ver960en.pdf