

System pro M compact® Miniature Circuit Breaker S 200 U and S 200 UP

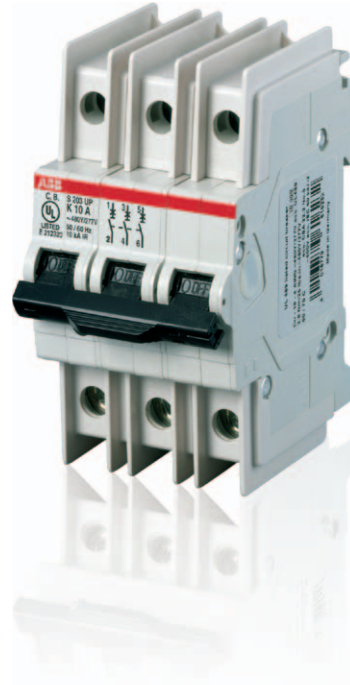

2CDC021316F0004



2CDC021320F0004

The S 200 U and S 200 UP ranges are miniature circuit breakers conforming to UL, CSA and IEC standards. They are a valuable addition to the well known system System pro M compact® range which allow most of the UL 489 and CSA 22.2 No. 5 approved components to be combined effortlessly.

Standards and approvals

Standards

UL 489
 CSA 22.2 No. 5
 IEC/EN 60947-2

Approvals

UL 489	US
CSA 22.2 No. 5	CA
VDE	DE
CCC* GB 14048.2	CN

* K- and Z-characteristic only

Miniature Circuit Breaker S 200 U and S 200 UP

Technical data

General Data	S 200 U	S 200 UP
Standards	IEC/EN 60947-2, UL489, CSA22.2 No.5	
Poles	1P, 2P, 3P, 4P	
Tripping characteristics	C, K, Z	
Rated current I_n	0.2...63 A	0.2...25 A
Rated frequency f	50/60 Hz	
Rated insulation voltage U_i	250 V AC (phase to ground), 500 V AC (phase to phase)	
Overvoltage Category	III	
Pollution Degree	3	
IEC/EN 60947-2		
Rated operational voltage U_n	1P: 230 V AC 2...4P: 400 V AC	
Max. power frequency recovery voltage U_{max}	1P: 253/440 V AC 2...4P: 440 V AC	
Min. operating voltage	12 V AC	
Rated short-circuit capacity I_{cn}	10 kA	
Rated service short-circuit breaking capacity I_{cs}	7.5 kA	
Rated impulse withstand voltage U_{imp} (1.2/50 μ s)	4 kV (test voltage 6.2kV at sea level, 5kV at 2,000m)	
Dielectric test voltage	2 kV (50 / 60Hz, 1 min.)	
Reference temperature for tripping characteristics	C, K, Z: 20°C	
Electrical endurance	$I_n < 32A$: 20,000 ops (AC), $I_n \geq 32A$: 10,000 ops. (AC); 1 cycle (2s - ON, 13s - OFF, $I_n \leq 32A$), 1 cycle (2s - ON, 28s - OFF, $I_n > 32A$)	
UL/CSA		
Rated operational voltage U_n	1P: 240 V AC 2...4P: 240 V AC	1P: 277 V AC 2...4P: 480Y / 277 V AC
Short-circuit current rating acc. to UL 489	10 kA	
Application	Suppl. prot. for general use. Application Codes: TC2, OL0, SC: U1	
Reference temperature for tripping characteristics	C, K, Z: 25°C	
Electrical endurance	6,000 ops (AC), 1 cycle (1s - ON, 9s - OFF)	
Mechanical data		
Housing	Insulation group I, RAL 7035	
Toggle	Insulation group II, black, sealable	
Contact position indication	Marking on toggle (I ON / 0 OFF), Real CPI (red ON / green OFF)	
Protection degree acc. to DIN EN 60529	IP20*, IP40 in enclosure with cover	
Mechanical endurance	20,000 ops.	
Shock resistance acc. to IEC/EN 60068-2-27	25 g - 2 shocks - 13 ms	
Vibration resistance acc. to IEC/EN 60068-2-6	5 g - 20 cycles at 5...150...5 Hz with load 0.8 I_n	
Environmental conditions (damp heat cyclic) acc. to IEC/EN 60068-2-30	28 cycles with 55°C/90-96% and 25°C/95-100%	
Ambient temperature	-25 ... +55 °C	
Storage temperature	-40 ... +70 °C	

* only with accessory: IP20 terminal clip

Miniature Circuit Breaker S 200 U and S 200 UP

Technical data

Installation		S 200 U	S 200 UP
Terminal		Failsafe bi-directional cylinder-lift terminal	
Cross-section of conductor (top/bottom)	Solid/stranded	25 mm ² / 25 mm ²	
	Flexible	16 mm ² / 16 mm ² , 18 - 4 AWG	
Cross-section of busbars (top/bottom)		10 mm ² / 10 mm ² , 18 - 8 AWG	
Tightening Torque		2.8 Nm 25 in-lbs.	
Screw driver		No. 2 Pozidrive	
Mounting		On DIN rail 35 mm acc. to EN 60715 by fast clip	
Mounting position		any	
Supply		optional	
Dimensions and weight			
Mounting dimensions acc. to DIN 43880		-	
Pole dimensions (H x D x W)		92 x 71 x 17.5 mm	100 x 71 x 17.5 mm
Pole weight		approx. 140 g	
Combination with auxiliary elements			
Auxiliary contact		Yes	
Signal contact		Yes	
Shunt trip		Yes	
Undervoltage release		No	
Motor operating device		No	

Miniature Circuit Breaker S 200 U and S 200 UP

Tripping characteristics, internal resistance and power loss

Tripping characteristics

C characteristic

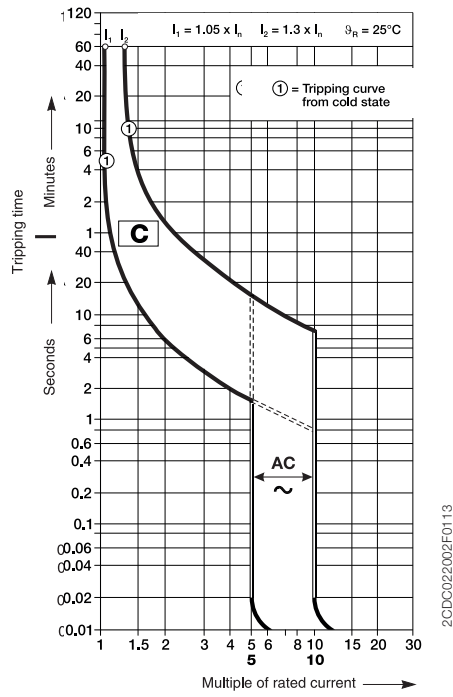

K characteristic

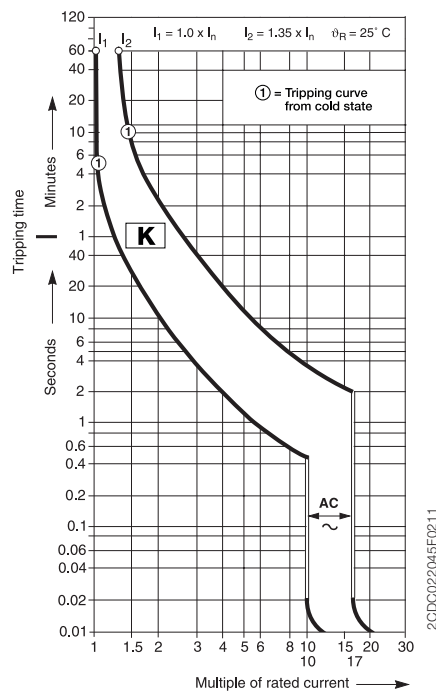

Z characteristic

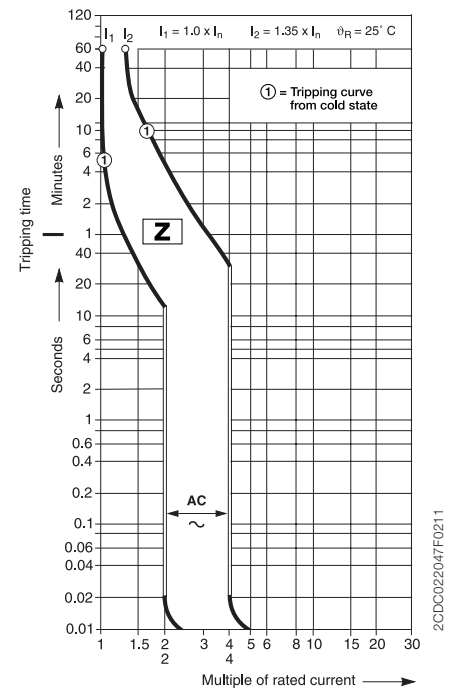

Internal resistance and power loss

Rated current I_n A	Tripping characteristic C		Tripping characteristic K		Tripping characteristic Z	
	Internal resistance R_i mΩ	Power loss P_v W	Internal resistance R_i mΩ	Power loss P_v W	Internal resistance R_i mΩ	Power loss P_v W
0.2	—	—	42500	1.7	—	—
0.3	—	—	20000	1.8	—	—
0.5	5500	1.4	6340	1.6	10100	2.5
0.75	—	—	2500	1.4	—	—
1	1440	1.4	1400	1.4	2270	2.3
1.6	630	1.6	625	1.6	1100	2.8
2	460	1.8	460	1.8	619	2.5
3	150	1.3	211	1.9	211	1.9
4	110	1.8	163	2.6	163	2.6
5	55.0	2.0	67	2.4	104	3.7
6	55.0	2.0	67	2.4	104	3.7
8	15.0	1.0	45	2.9	55	3.5
10	13.3	1.3	19	1.9	21	2.1
13	13.3	2.3	8.2	2.1	—	—
15	7.0	1.8	8.2	2.1	10.9	2.8
16	7.0	1.8	8.2	2.1	10.9	2.8
20	6.25	2.5	7.3	2.9	7.3	2.9
25	5.0	3.2	5.6	3.5	5.6	3.5
30	3.6	3.7	4.1	4.2	4.1	4.2
32	3.6	3.7	4.1	4.2	4.1	4.2
40	3.0	4.8	4.0	6.4	4.0	6.4
50	1.3	3.25	1.2	3.0	1.8	4.4
60	1.2	4.8	1.3	5.2	1.3	5.2
63	1.2	4.8	1.3	5.2	1.3	5.2

Miniature Circuit Breaker S 200 U and S 200 UP

Derating and dimensional drawings

Deviating ambient temperature

The rated value of the current of a miniature circuit breaker refers to a temperature of 20 °C for circuit-breakers with characteristics C, K and Z. The following table contains the derating of load capability of S 200 U/UP MCBs with temperature from -40 °C to 70 °C for the curves C, K, and Z.

For installations of miniature circuit breakers at other temperatures than the reference value and installations of several miniature circuit breakers directly side by side, derating factors have to be considered.

Tripping characteristics	Rated current I_n A	Maximum operating current at ambient temperature T											
		°C											
		- 40	- 30	- 20	- 10	0	10	20	30	40	50	60	70
C, K, Z	0.5	0.67	0.64	0.61	0.59	0.56	0.53	0.50	0.47	0.43	0.40	0.35	0.31
	1.0	1.32	1.27	1.22	1.17	1.12	1.08	1.00	0.94	0.87	0.79	0.71	0.61
	1.6	2.12	2.04	1.96	1.88	1.79	1.70	1.60	1.50	1.39	1.26	1.13	0.98
	2.0	2.65	2.55	2.45	2.35	2.24	2.12	2.00	1.87	1.73	1.58	1.41	1.22
	3.0	4.0	3.8	3.7	3.5	3.4	3.2	3.0	2.8	2.6	2.4	2.1	1.8
	4.0	5.3	5.1	4.9	4.7	4.5	4.2	4.0	3.8	3.5	3.2	2.8	2.4
	6.0	7.9	7.6	7.3	7.0	6.7	6.4	6.0	5.8	5.2	4.7	4.2	3.7
	8.0	10.8	10.2	9.8	9.4	8.9	8.5	8.0	7.5	6.9	6.3	5.7	4.9
	10.0	13.2	12.7	12.2	11.7	11.2	10.6	10.0	9.4	8.7	7.9	7.1	6.1
	13.0	17.2	16.6	15.9	15.2	14.5	13.8	13.0	12.2	11.3	10.3	9.2	8.0
	16.0	21.2	20.4	19.6	18.8	17.9	17.0	16.0	15.0	13.9	12.6	11.3	9.8
	20.0	26.5	25.5	24.5	23.5	22.4	21.2	20.0	18.7	17.3	15.8	14.1	12.2
	25.0	33.1	31.9	30.6	29.3	28.0	26.5	25.0	23.4	21.7	19.8	17.7	15.3
	32.0	42.3	40.8	39.2	37.5	35.8	33.9	32.0	29.9	27.7	25.3	22.6	19.6
	40.0	52.9	51.0	49.0	46.9	44.7	42.4	40.0	37.4	34.6	31.6	28.3	24.5
50.0	66.1	63.7	61.2	58.6	55.9	53.0	50.0	46.8	43.3	39.6	35.4	30.6	
63.0	83.3	80.3	77.2	73.9	70.4	66.8	63.0	58.9	54.6	49.8	44.5	38.5	

Influence of adjacent devices

If several miniature circuit breakers are installed directly side by side with high load on all poles, a correction factor must be applied to the rated current (see table). If distance pieces are used, the factor is not to be considered.

No. of adjacent devices	Factor F
1	1
2, 3	0.9
4, 5	0.8
≥ 6	0.75

Dimensional drawings

S 200 U

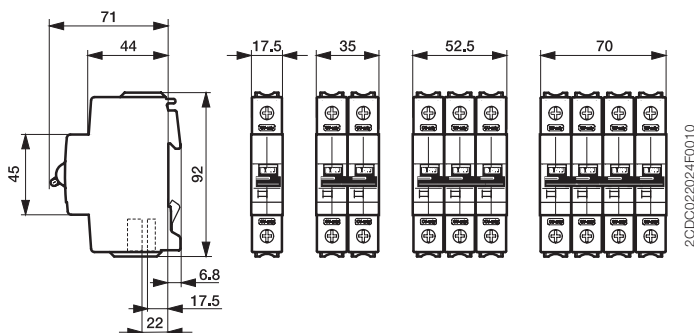

S 200 UP

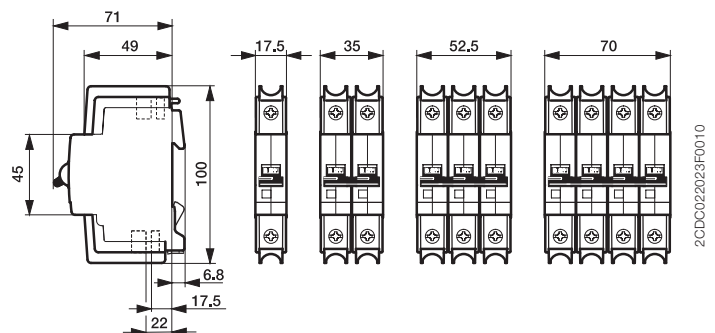

Miniature Circuit Breaker S 200 U

Ordering data characteristic C



S 201 U

2CDC021314F0004



S 202 U

2CDC021315F0004

Number of poles	Rated current I_n A	Type	Order code	bbn/EAN	Packing unit	Weight per PCE
					PCE	kg
1	0.5	S201U-C0.5	2CDS271417R0984	4016779854726	10	0.140
	1	S201U-C1	2CDS271417R0014	4016779854740	10	0.140
	1.6	S201U-C1.6	2CDS271417R0974	4016779854757	10	0.140
	2	S201U-C2	2CDS271417R0024	4016779858366	10	0.140
	3	S201U-C3	2CDS271417R0034	4016779858373	10	0.140
	4	S201U-C4	2CDS271417R0044	4016779858380	10	0.140
	5	S201U-C5	2CDS271417R0054	4016779858397	10	0.140
	6	S201U-C6	2CDS271417R0064	4016779858403	10	0.140
	8	S201U-C8	2CDS271417R0084	4016779858410	10	0.140
	10	S201U-C10	2CDS271417R0104	4016779858427	10	0.140
	13	S201U-C13	2CDS271417R0134	4016779858434	10	0.140
	15	S201U-C15	2CDS271417R0154	4016779858441	10	0.140
	16	S201U-C16	2CDS271417R0164	4016779858458	10	0.140
	20	S201U-C20	2CDS271417R0204	4016779858465	10	0.140
	25	S201U-C25	2CDS271417R0254	4016779858472	10	0.140
	30	S201U-C30	2CDS271417R0304	4016779858489	10	0.140
	32	S201U-C32	2CDS271417R0324	4016779858496	10	0.140
	40	S201U-C40	2CDS271417R0404	4016779858502	10	0.140
	50	S201U-C50	2CDS271417R0504	4016779858519	10	0.140
	60	S201U-C60	2CDS271417R0604	4016779858526	10	0.140
63	S201U-C63	2CDS271417R0634	4016779858533	10	0.140	
2	0.5	S202U-C0.5	2CDS272417R0984	4016779858564	5	0.280
	1	S202U-C1	2CDS272417R0014	4016779858588	5	0.280
	1.6	S202U-C1.6	2CDS272417R0974	4016779858595	5	0.280
	2	S202U-C2	2CDS272417R0024	4016779858601	5	0.280
	3	S202U-C3	2CDS272417R0034	4016779858618	5	0.280
	4	S202U-C4	2CDS272417R0044	4016779858625	5	0.280
	5	S202U-C5	2CDS272417R0054	4016779858632	5	0.280
	6	S202U-C6	2CDS272417R0064	4016779858649	5	0.280
	8	S202U-C8	2CDS272417R0084	4016779858656	5	0.280
	10	S202U-C10	2CDS272417R0104	4016779858663	5	0.280
	13	S202U-C13	2CDS272417R0134	4016779858670	5	0.280
	15	S202U-C15	2CDS272417R0154	4016779858687	5	0.280
	16	S202U-C16	2CDS272417R0164	4016779858694	5	0.280
	20	S202U-C20	2CDS272417R0204	4016779858700	5	0.280
	25	S202U-C25	2CDS272417R0254	4016779858717	5	0.280
	30	S202U-C30	2CDS272417R0304	4016779858724	5	0.280
	32	S202U-C32	2CDS272417R0324	4016779858731	5	0.280
	40	S202U-C40	2CDS272417R0404	4016779858748	5	0.280
	50	S202U-C50	2CDS272417R0504	4016779858755	5	0.280
	60	S202U-C60	2CDS272417R0604	4016779858762	5	0.280
63	S202U-C63	2CDS272417R0634	4016779858779	5	0.280	

Miniature Circuit Breaker S 200 U

Ordering data characteristic C



S 203 U

2CDC0021316F0004



S 204 U

2CDC0021317F0004

Number of poles	Rated current I_n A	Type	Order code	bbn/EAN	Packing unit	Weight per PCE
					PCE	kg
3	0.5	S203U-C0.5	2CDS273417R0984	4016779858809	3	0.420
	1	S203U-C1	2CDS273417R0014	4016779858823	3	0.420
	1.6	S203U-C1.6	2CDS273417R0974	4016779858830	3	0.420
	2	S203U-C2	2CDS273417R0024	4016779858847	3	0.420
	3	S203U-C3	2CDS273417R0034	4016779858854	3	0.420
	4	S203U-C4	2CDS273417R0044	4016779858861	3	0.420
	5	S203U-C5	2CDS273417R0054	4016779858878	3	0.420
	6	S203U-C6	2CDS273417R0064	4016779858885	3	0.420
	8	S203U-C8	2CDS273417R0084	4016779858892	3	0.420
	10	S203U-C10	2CDS273417R0104	4016779858908	3	0.420
	13	S203U-C13	2CDS273417R0134	4016779858915	3	0.420
	15	S203U-C15	2CDS273417R0154	4016779858922	3	0.420
	16	S203U-C16	2CDS273417R0164	4016779858939	3	0.420
	20	S203U-C20	2CDS273417R0204	4016779858946	3	0.420
	25	S203U-C25	2CDS273417R0254	4016779858953	3	0.420
	30	S203U-C30	2CDS273417R0304	4016779858960	3	0.420
	32	S203U-C32	2CDS273417R0324	4016779858977	3	0.420
40	S203U-C40	2CDS273417R0404	4016779858984	3	0.420	
50	S203U-C50	2CDS273417R0504	4016779858991	3	0.420	
60	S203U-C60	2CDS273417R0604	4016779859004	3	0.420	
63	S203U-C63	2CDS273417R0634	4016779859011	3	0.420	
4	0.5	S204U-C0.5	2CDS274417R0984	4016779859042	2	0.560
	1	S204U-C1	2CDS274417R0014	4016779859066	2	0.560
	1.6	S204U-C1.6	2CDS274417R0974	4016779859073	2	0.560
	2	S204U-C2	2CDS274417R0024	4016779859080	2	0.560
	3	S204U-C3	2CDS274417R0034	4016779859097	2	0.560
	4	S204U-C4	2CDS274417R0044	4016779859103	2	0.560
	5	S204U-C5	2CDS274417R0054	4016779859110	2	0.560
	6	S204U-C6	2CDS274417R0064	4016779859127	2	0.560
	8	S204U-C8	2CDS274417R0084	4016779859134	2	0.560
	10	S204U-C10	2CDS274417R0104	4016779859141	2	0.560
	13	S204U-C13	2CDS274417R0134	4016779859158	2	0.560
	15	S204U-C15	2CDS274417R0154	4016779859165	2	0.560
	16	S204U-C16	2CDS274417R0164	4016779859172	2	0.560
	20	S204U-C20	2CDS274417R0204	4016779859189	2	0.560
	25	S204U-C25	2CDS274417R0254	4016779859196	2	0.560
	30	S204U-C30	2CDS274417R0304	4016779859202	2	0.560
	32	S204U-C32	2CDS274417R0324	4016779859219	2	0.560
40	S204U-C40	2CDS274417R0404	4016779859226	2	0.560	
50	S204U-C50	2CDS274417R0504	4016779859233	2	0.560	
60	S204U-C60	2CDS274417R0604	4016779859240	2	0.560	
63	S204U-C63	2CDS274417R0634	4016779859257	2	0.560	

Miniature Circuit Breaker S 200 U

Ordering data characteristic K



2CDC021314F0004

S 201 U



2CDC021315F0004

S 202 U

Number of poles	Rated current I_n A	Type	Order code	bbn/EAN	Packing unit	Weight per PCE
					PCE	kg
1	0.2	S201U-K0.2	2CDS271417R0087	4016779619226	10	0.140
	0.3	S201U-K0.3	2CDS271417R0117	4016779619233	10	0.140
	0.5	S201U-K0.5	2CDS271417R0157	4016779619240	10	0.140
	0.75	S201U-K0.75	2CDS271417R0187	4016779619257	10	0.140
	1	S201U-K1	2CDS271417R0217	4016779619264	10	0.140
	1.6	S201U-K1.6	2CDS271417R0257	4016779619271	10	0.140
	2	S201U-K2	2CDS271417R0277	4016779619288	10	0.140
	3	S201U-K3	2CDS271417R0317	4016779619295	10	0.140
	4	S201U-K4	2CDS271417R0337	4016779619301	10	0.140
	5	S201U-K5	2CDS271417R0357	4016779619318	10	0.140
	6	S201U-K6	2CDS271417R0377	4016779619325	10	0.140
	8	S201U-K8	2CDS271417R0407	4016779619332	10	0.140
	10	S201U-K10	2CDS271417R0427	4016779619349	10	0.140
	13	S201U-K13	2CDS271417R0447	4016779619356	10	0.140
	15	S201U-K15	2CDS271417R0457	4016779619363	10	0.140
	16	S201U-K16	2CDS271417R0467	4016779619370	10	0.140
	20	S201U-K20	2CDS271417R0487	4016779619387	10	0.140
	25	S201U-K25	2CDS271417R0517	4016779619394	10	0.140
	30	S201U-K30	2CDS271417R0527	4016779619400	10	0.140
	32	S201U-K32	2CDS271417R0537	4016779619417	10	0.140
40	S201U-K40	2CDS271417R0557	4016779619424	10	0.140	
50	S201U-K50	2CDS271417R0577	4016779619431	10	0.140	
60	S201U-K60	2CDS271417R0587	4016779619448	10	0.140	
63	S201U-K63	2CDS271417R0607	4016779619455	10	0.140	
2	0.2	S202U-K0.2	2CDS272417R0087	4016779619462	5	0.280
	0.3	S202U-K0.3	2CDS272417R0117	4016779619479	5	0.280
	0.5	S202U-K0.5	2CDS272417R0157	4016779619486	5	0.280
	0.75	S202U-K0.75	2CDS272417R0187	4016779619493	5	0.280
	1	S202U-K1	2CDS272417R0217	4016779619509	5	0.280
	1.6	S202U-K1.6	2CDS272417R0257	4016779619516	5	0.280
	2	S202U-K2	2CDS272417R0277	4016779619523	5	0.280
	3	S202U-K3	2CDS272417R0317	4016779619530	5	0.280
	4	S202U-K4	2CDS272417R0337	4016779619547	5	0.280
	5	S202U-K5	2CDS272417R0357	4016779619554	5	0.280
	6	S202U-K6	2CDS272417R0377	4016779619561	5	0.280
	8	S202U-K8	2CDS272417R0407	4016779619578	5	0.280
	10	S202U-K10	2CDS272417R0427	4016779619585	5	0.280
	13	S202U-K13	2CDS272417R0447	4016779619592	5	0.280
	15	S202U-K15	2CDS272417R0457	4016779619608	5	0.280
	16	S202U-K16	2CDS272417R0467	4016779619615	5	0.280
	20	S202U-K20	2CDS272417R0487	4016779619622	5	0.280
	25	S202U-K25	2CDS272417R0517	4016779619639	5	0.280
	30	S202U-K30	2CDS272417R0527	4016779619646	5	0.280
	32	S202U-K32	2CDS272417R0537	4016779619653	5	0.280
40	S202U-K40	2CDS272417R0557	4016779619660	5	0.280	
50	S202U-K50	2CDS272417R0577	4016779619677	5	0.280	
60	S202U-K60	2CDS272417R0587	4016779619684	5	0.280	
63	S202U-K63	2CDS272417R0607	4016779619691	5	0.280	

Miniature Circuit Breaker S 200 U

Ordering data characteristic K



S 203 U

2CDC0021316F0004

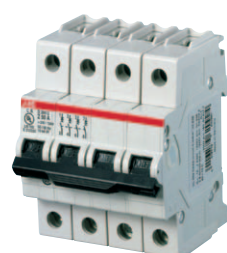

S 204 U

2CDC0021317F0004

Number of poles	Rated current I_n A	Type	Order code	bbn/EAN	Packing unit	Weight per PCE
					PCE	kg
3	0.2	S203U-K0.2	2CDS273417R0087	4016779619707	3	0.420
	0.3	S203U-K0.3	2CDS273417R0117	4016779619714	3	0.420
	0.5	S203U-K0.5	2CDS273417R0157	4016779619721	3	0.420
	0.75	S203U-K0.75	2CDS273417R0187	4016779619738	3	0.420
	1	S203U-K1	2CDS273417R0217	4016779619745	3	0.420
	1.6	S203U-K1.6	2CDS273417R0257	4016779619752	3	0.420
	2	S203U-K2	2CDS273417R0277	4016779619769	3	0.420
	3	S203U-K3	2CDS273417R0317	4016779619776	3	0.420
	4	S203U-K4	2CDS273417R0337	4016779619783	3	0.420
	5	S203U-K5	2CDS273417R0357	4016779619790	3	0.420
	6	S203U-K6	2CDS273417R0377	4016779619806	3	0.420
	8	S203U-K8	2CDS273417R0407	4016779619813	3	0.420
	10	S203U-K10	2CDS273417R0427	4016779619820	3	0.420
	13	S203U-K13	2CDS273417R0447	4016779619837	3	0.420
	15	S203U-K15	2CDS273417R0457	4016779619844	3	0.420
	16	S203U-K16	2CDS273417R0467	4016779619851	3	0.420
	20	S203U-K20	2CDS273417R0487	4016779619868	3	0.420
	25	S203U-K25	2CDS273417R0517	4016779619875	3	0.420
	30	S203U-K30	2CDS273417R0527	4016779619882	3	0.420
	32	S203U-K32	2CDS273417R0537	4016779619899	3	0.420
40	S203U-K40	2CDS273417R0557	4016779619905	3	0.420	
50	S203U-K50	2CDS273417R0577	4016779619912	3	0.420	
60	S203U-K60	2CDS273417R0587	4016779619929	3	0.420	
63	S203U-K63	2CDS273417R0607	4016779619936	3	0.420	
4	0.2	S204U-K0.2	2CDS274417R0087	4016779619943	2	0.560
	0.3	S204U-K0.3	2CDS274417R0117	4016779619950	2	0.560
	0.5	S204U-K0.5	2CDS274417R0157	4016779619967	2	0.560
	0.75	S204U-K0.75	2CDS274417R0187	4016779619974	2	0.560
	1	S204U-K1	2CDS274417R0217	4016779619981	2	0.560
	1.6	S204U-K1.6	2CDS274417R0257	4016779619998	2	0.560
	2	S204U-K2	2CDS274417R0277	4016779620000	2	0.560
	3	S204U-K3	2CDS274417R0317	4016779620017	2	0.560
	4	S204U-K4	2CDS274417R0337	4016779620024	2	0.560
	5	S204U-K5	2CDS274417R0357	4016779620031	2	0.560
	6	S204U-K6	2CDS274417R0377	4016779620048	2	0.560
	8	S204U-K8	2CDS274417R0407	4016779620055	2	0.560
	10	S204U-K10	2CDS274417R0427	4016779620062	2	0.560
	13	S204U-K13	2CDS274417R0447	4016779620079	2	0.560
	15	S204U-K15	2CDS274417R0457	4016779620086	2	0.560
	16	S204U-K16	2CDS274417R0467	4016779620093	2	0.560
	20	S204U-K20	2CDS274417R0487	4016779620109	2	0.560
	25	S204U-K25	2CDS274417R0517	4016779620116	2	0.560
	30	S204U-K30	2CDS274417R0527	4016779620123	2	0.560
	32	S204U-K32	2CDS274417R0537	4016779620130	2	0.560
40	S204U-K40	2CDS274417R0557	4016779620147	2	0.560	
50	S204U-K50	2CDS274417R0577	4016779620154	2	0.560	
60	S204U-K60	2CDS274417R0587	4016779620161	2	0.560	
63	S204U-K63	2CDS274417R0607	4016779620178	2	0.560	

Miniature Circuit Breaker S 200 U

Ordering data characteristic Z



2CDC021314F0004

S 201 U



2CDC021315F0004

S 202 U

Number of poles	Rated current I_n A	Type	Order code	bbn/EAN	Packing unit	Weight per PCE
					PCE	kg
1	0.5	S201U-Z0.5	2CDS271417R0158	4016779620185	10	0.140
	1	S201U-Z1	2CDS271417R0218	4016779620192	10	0.140
	1.6	S201U-Z1.6	2CDS271417R0258	4016779620208	10	0.140
	2	S201U-Z2	2CDS271417R0278	4016779620215	10	0.140
	3	S201U-Z3	2CDS271417R0318	4016779620222	10	0.140
	4	S201U-Z4	2CDS271417R0338	4016779620239	10	0.140
	5	S201U-Z5	2CDS271417R0358	4016779620246	10	0.140
	6	S201U-Z6	2CDS271417R0378	4016779620253	10	0.140
	8	S201U-Z8	2CDS271417R0408	4016779620260	10	0.140
	10	S201U-Z10	2CDS271417R0428	4016779620277	10	0.140
	13	S201U-Z13	2CDS271417R0448	4016779620284	10	0.140
	15	S201U-Z15	2CDS271417R0458	4016779620291	10	0.140
	16	S201U-Z16	2CDS271417R0468	4016779620307	10	0.140
	20	S201U-Z20	2CDS271417R0488	4016779620314	10	0.140
	25	S201U-Z25	2CDS271417R0518	4016779620321	10	0.140
	30	S201U-Z30	2CDS271417R0528	4016779622851	10	0.140
	32	S201U-Z32	2CDS271417R0538	4016779620345	10	0.140
	40	S201U-Z40	2CDS271417R0558	4016779620352	10	0.140
	50	S201U-Z50	2CDS271417R0578	4016779620369	10	0.140
	60	S201U-Z60	2CDS271417R0588	4016779620376	10	0.140
63	S201U-Z63	2CDS271417R0608	4016779620383	10	0.140	
2	0.5	S202U-Z0.5	2CDS272417R0158	4016779620390	5	0.280
	1	S202U-Z1	2CDS272417R0218	4016779620406	5	0.280
	1.6	S202U-Z1.6	2CDS272417R0258	4016779620413	5	0.280
	2	S202U-Z2	2CDS272417R0278	4016779620420	5	0.280
	3	S202U-Z3	2CDS272417R0318	4016779620437	5	0.280
	4	S202U-Z4	2CDS272417R0338	4016779620444	5	0.280
	5	S202U-Z5	2CDS272417R0358	4016779620451	5	0.280
	6	S202U-Z6	2CDS272417R0378	4016779620468	5	0.280
	8	S202U-Z8	2CDS272417R0408	4016779620475	5	0.280
	10	S202U-Z10	2CDS272417R0428	4016779620482	5	0.280
	13	S202U-Z13	2CDS272417R0448	4016779620499	5	0.280
	15	S202U-Z15	2CDS272417R0458	4016779620505	5	0.280
	16	S202U-Z16	2CDS272417R0468	4016779620512	5	0.280
	20	S202U-Z20	2CDS272417R0488	4016779620529	5	0.280
	25	S202U-Z25	2CDS272417R0518	4016779620536	5	0.280
	30	S202U-Z30	2CDS272417R0528	4016779620543	5	0.280
	32	S202U-Z32	2CDS272417R0538	4016779620550	5	0.280
	40	S202U-Z40	2CDS272417R0558	4016779620567	5	0.280
	50	S202U-Z50	2CDS272417R0578	4016779620574	5	0.280
	60	S202U-Z60	2CDS272417R0588	4016779620581	5	0.280
63	S202U-Z63	2CDS272417R0608	4016779620598	5	0.280	

Miniature Circuit Breaker S 200 U

Ordering data characteristic Z

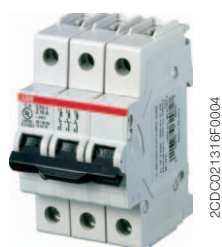

S 203 U

2CDC0021316F0004

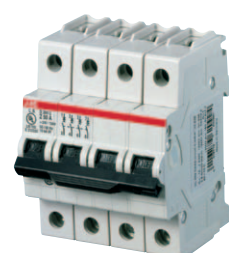

S 204 U

2CDC0021317F0004

Number of poles	Rated current I_n A	Type	Order code	bbn/EAN	Packing unit	Weight per PCE
					PCE	kg
3	0.5	S203U-Z0.5	2CDS273417R0158	4016779620604	3	0.420
	1	S203U-Z1	2CDS273417R0218	4016779620611	3	0.420
	1.6	S203U-Z1.6	2CDS273417R0258	4016779620628	3	0.420
	2	S203U-Z2	2CDS273417R0278	4016779620635	3	0.420
	3	S203U-Z3	2CDS273417R0318	4016779620642	3	0.420
	4	S203U-Z4	2CDS273417R0338	4016779620659	3	0.420
	5	S203U-Z5	2CDS273417R0358	4016779620666	3	0.420
	6	S203U-Z6	2CDS273417R0378	4016779620673	3	0.420
	8	S203U-Z8	2CDS273417R0408	4016779620680	3	0.420
	10	S203U-Z10	2CDS273417R0428	4016779620697	3	0.420
	13	S203U-Z13	2CDS273417R0448	4016779620703	3	0.420
	15	S203U-Z15	2CDS273417R0458	4016779620710	3	0.420
	16	S203U-Z16	2CDS273417R0468	4016779620727	3	0.420
	20	S203U-Z20	2CDS273417R0488	4016779620734	3	0.420
	25	S203U-Z25	2CDS273417R0518	4016779620741	3	0.420
	30	S203U-Z30	2CDS273417R0528	4016779620758	3	0.420
32	S203U-Z32	2CDS273417R0538	4016779620765	3	0.420	
40	S203U-Z40	2CDS273417R0558	4016779620772	3	0.420	
50	S203U-Z50	2CDS273417R0578	4016779620789	3	0.420	
60	S203U-Z60	2CDS273417R0588	4016779620796	3	0.420	
63	S203U-Z63	2CDS273417R0608	4016779620802	3	0.420	
4	0.5	S204U-Z0.5	2CDS274417R0158	4016779620819	2	0.560
	1	S204U-Z1	2CDS274417R0218	4016779620826	2	0.560
	1.6	S204U-Z1.6	2CDS274417R0258	4016779620833	2	0.560
	2	S204U-Z2	2CDS274417R0278	4016779620840	2	0.560
	3	S204U-Z3	2CDS274417R0318	4016779620857	2	0.560
	4	S204U-Z4	2CDS274417R0338	4016779620864	2	0.560
	5	S204U-Z5	2CDS274417R0358	4016779620871	2	0.560
	6	S204U-Z6	2CDS274417R0378	4016779620888	2	0.560
	8	S204U-Z8	2CDS274417R0408	4016779620895	2	0.560
	10	S204U-Z10	2CDS274417R0428	4016779620901	2	0.560
	13	S204U-Z13	2CDS274417R0448	4016779620918	2	0.560
	15	S204U-Z15	2CDS274417R0458	4016779620925	2	0.560
	16	S204U-Z16	2CDS274417R0468	4016779620932	2	0.560
	20	S204U-Z20	2CDS274417R0488	4016779620949	2	0.560
	25	S204U-Z25	2CDS274417R0518	4016779620956	2	0.560
	30	S204U-Z30	2CDS274417R0528	4016779620963	2	0.560
32	S204U-Z32	2CDS274417R0538	4016779620970	2	0.560	
40	S204U-Z40	2CDS274417R0558	4016779620987	2	0.560	
50	S204U-Z50	2CDS274417R0578	4016779620994	2	0.560	
60	S204U-Z60	2CDS274417R0588	4016779621007	2	0.560	
63	S204U-Z63	2CDS274417R0608	4016779621014	2	0.560	

Miniature Circuit Breaker S 200 UP

Ordering data characteristic C



2CDC0021318F0004

S 201 UP



2CDC0021319F0004

S 202 UP



2CDC0021320F0004

S 203 UP



2CDC0021321F0004

S 204 UP

Number of poles	Rated current I_n A	Type	Order code	bbn/EAN	Packing unit	Weight per PCE
					PCE	kg
1	0.5	S201UP-C0.5	2CDS271317R0984	4016779862462	10	0.140
	1	S201UP-C1	2CDS271317R0014	4016779862486	10	0.140
	1,6	S201UP-C1,6	2CDS271317R0974	4016779862493	10	0.140
	2	S201UP-C2	2CDS271317R0024	4016779862509	10	0.140
	3	S201UP-C3	2CDS271317R0034	4016779862516	10	0.140
	4	S201UP-C4	2CDS271317R0044	4016779862523	10	0.140
	5	S201UP-C5	2CDS271317R0054	4016779862530	10	0.140
	6	S201UP-C6	2CDS271317R0064	4016779862547	10	0.140
	8	S201UP-C8	2CDS271317R0084	4016779862554	10	0.140
	10	S201UP-C10	2CDS271317R0104	4016779862561	10	0.140
	13	S201UP-C13	2CDS271317R0134	4016779862578	10	0.140
	15	S201UP-C15	2CDS271317R0154	4016779862585	10	0.140
	16	S201UP-C16	2CDS271317R0164	4016779862592	10	0.140
	20	S201UP-C20	2CDS271317R0204	4016779862608	10	0.140
	25	S201UP-C25	2CDS271317R0254	4016779862615	10	0.140
	2	0.5	S202UP-C0.5	2CDS272317R0984	4016779862622	5
1		S202UP-C1	2CDS272317R0014	4016779862646	5	0.280
1,6		S202UP-C1,6	2CDS272317R0974	4016779862653	5	0.280
2		S202UP-C2	2CDS272317R0024	4016779862660	5	0.280
3		S202UP-C3	2CDS272317R0034	4016779862677	5	0.280
4		S202UP-C4	2CDS272317R0044	4016779862684	5	0.280
5		S202UP-C5	2CDS272317R0054	4016779862691	5	0.280
6		S202UP-C6	2CDS272317R0064	4016779862707	5	0.280
8		S202UP-C8	2CDS272317R0084	4016779862714	5	0.280
10		S202UP-C10	2CDS272317R0104	4016779862721	5	0.280
13		S202UP-C13	2CDS272317R0134	4016779862738	5	0.280
15		S202UP-C15	2CDS272317R0154	4016779862745	5	0.280
16		S202UP-C16	2CDS272317R0164	4016779862752	5	0.280
20		S202UP-C20	2CDS272317R0204	4016779862769	5	0.280
25		S202UP-C25	2CDS272317R0254	4016779862776	5	0.280
3		0.5	S203UP-C0.5	2CDS273317R0984	4016779862783	3
	1	S203UP-C1	2CDS273317R0014	4016779862806	3	0.420
	1,6	S203UP-C1,6	2CDS273317R0974	4016779862813	3	0.420
	2	S203UP-C2	2CDS273317R0024	4016779862820	3	0.420
	3	S203UP-C3	2CDS273317R0034	4016779862837	3	0.420
	4	S203UP-C4	2CDS273317R0044	4016779862844	3	0.420
	5	S203UP-C5	2CDS273317R0054	4016779862851	3	0.420
	6	S203UP-C6	2CDS273317R0064	4016779862868	3	0.420
	8	S203UP-C8	2CDS273317R0084	4016779862875	3	0.420
	10	S203UP-C10	2CDS273317R0104	4016779862882	3	0.420
	13	S203UP-C13	2CDS273317R0134	4016779862899	3	0.420
	15	S203UP-C15	2CDS273317R0154	4016779862905	3	0.420
	16	S203UP-C16	2CDS273317R0164	4016779862912	3	0.420
	20	S203UP-C20	2CDS273317R0204	4016779862929	3	0.420
	25	S203UP-C25	2CDS273317R0254	4016779862936	3	0.420
	4	0.5	S204UP-C0.5	2CDS274317R0984	4016779862943	2
1		S204UP-C1	2CDS274317R0014	4016779862967	2	0.560
1,6		S204UP-C1,6	2CDS274317R0974	4016779862974	2	0.560
2		S204UP-C2	2CDS274317R0024	4016779862981	2	0.560
3		S204UP-C3	2CDS274317R0034	4016779862998	2	0.560
4		S204UP-C4	2CDS274317R0044	4016779863001	2	0.560
5		S204UP-C5	2CDS274317R0054	4016779863018	2	0.560
6		S204UP-C6	2CDS274317R0064	4016779863025	2	0.560
8		S204UP-C8	2CDS274317R0084	4016779863032	2	0.560
10		S204UP-C10	2CDS274317R0104	4016779863049	2	0.560
13		S204UP-C13	2CDS274317R0134	4016779863056	2	0.560
15		S204UP-C15	2CDS274317R0154	4016779863063	2	0.560
16		S204UP-C16	2CDS274317R0164	4016779863070	2	0.560
20		S204UP-C20	2CDS274317R0204	4016779863087	2	0.560
25		S204UP-C25	2CDS274317R0254	4016779863094	2	0.560

Miniature Circuit Breaker S 200 UP

Ordering data characteristic K



2CDC0021319F0004

S 201 UP



2CDC0021319F0004

S 202 UP

Number of poles	Rated current I_n A	Type	Order code	bbn/EAN	Packing unit	Weight per PCE	
					PCE	kg	
1	0.2	S201UP-K0.2	2CDS271317R0087	4016779615631	10	0.140	
	0.3	S201UP-K0.3	2CDS271317R0117	4016779615648	10	0.140	
	0.5	S201UP-K0.5	2CDS271317R0157	4016779615655	10	0.140	
	0.75	S201UP-K0.75	2CDS271317R0187	4016779615662	10	0.140	
	1	S201UP-K1	2CDS271317R0217	4016779615679	10	0.140	
	1.6	S201UP-K1.6	2CDS271317R0257	4016779615686	10	0.140	
	2	S201UP-K2	2CDS271317R0277	4016779615693	10	0.140	
	3	S201UP-K3	2CDS271317R0317	4016779615709	10	0.140	
	4	S201UP-K4	2CDS271317R0337	4016779615716	10	0.140	
	5	S201UP-K5	2CDS271317R0357	4016779615723	10	0.140	
	6	S201UP-K6	2CDS271317R0377	4016779615730	10	0.140	
	8	S201UP-K8	2CDS271317R0407	4016779615747	10	0.140	
	10	S201UP-K10	2CDS271317R0427	4016779615754	10	0.140	
	13	S201UP-K13	2CDS271317R0447	4016779615761	10	0.140	
	15	S201UP-K15	2CDS271317R0457	4016779615778	10	0.140	
	16	S201UP-K16	2CDS271317R0467	4016779615785	10	0.140	
	20	S201UP-K20	2CDS271317R0487	4016779615792	10	0.140	
	25	S201UP-K25	2CDS271317R0517	4016779615808	10	0.140	
	2	0.2	S202UP-K0.2	2CDS272317R0087	4016779615877	5	0.280
		0.3	S202UP-K0.3	2CDS272317R0117	4016779615884	5	0.280
0.5		S202UP-K0.5	2CDS272317R0157	4016779615891	5	0.280	
0.75		S202UP-K0.75	2CDS272317R0187	4016779615907	5	0.280	
1		S202UP-K1	2CDS272317R0217	4016779615914	5	0.280	
1.6		S202UP-K1.6	2CDS272317R0257	4016779615921	5	0.280	
2		S202UP-K2	2CDS272317R0277	4016779615938	5	0.280	
3		S202UP-K3	2CDS272317R0317	4016779615945	5	0.280	
4		S202UP-K4	2CDS272317R0337	4016779615952	5	0.280	
5		S202UP-K5	2CDS272317R0357	4016779615969	5	0.280	
6		S202UP-K6	2CDS272317R0377	4016779615976	5	0.280	
8		S202UP-K8	2CDS272317R0407	4016779615983	5	0.280	
10		S202UP-K10	2CDS272317R0427	4016779615990	5	0.280	
13		S202UP-K13	2CDS272317R0447	4016779616003	5	0.280	
15		S202UP-K15	2CDS272317R0457	4016779616010	5	0.280	
16		S202UP-K16	2CDS272317R0467	4016779616027	5	0.280	
20		S202UP-K20	2CDS272317R0487	4016779616034	5	0.280	
25	S202UP-K25	2CDS272317R0517	4016779616041	5	0.280		

Miniature Circuit Breaker S 200 UP

Ordering data characteristic K



S 203 UP

2CDC021320F0004



S 204 UP

2CDC021321F0004

Number of poles	Rated current I_n A	Type	Order code	bbn/EAN	Packing unit	Weight per PCE
					PCE	kg
3	0.2	S203UP-K0.2	2CDS273317R0087	4016779616119	3	0.420
	0.3	S203UP-K0.3	2CDS273317R0117	4016779616126	3	0.420
	0.5	S203UP-K0.5	2CDS273317R0157	4016779616133	3	0.420
	0.75	S203UP-K0.75	2CDS273317R0187	4016779616140	3	0.420
	1	S203UP-K1	2CDS273317R0217	4016779616157	3	0.420
	1.6	S203UP-K1.6	2CDS273317R0257	4016779616164	3	0.420
	2	S203UP-K2	2CDS273317R0277	4016779616171	3	0.420
	3	S203UP-K3	2CDS273317R0317	4016779616188	3	0.420
	4	S203UP-K4	2CDS273317R0337	4016779616195	3	0.420
	5	S203UP-K5	2CDS273317R0357	4016779616201	3	0.420
	6	S203UP-K6	2CDS273317R0377	4016779616218	3	0.420
	8	S203UP-K8	2CDS273317R0407	4016779616225	3	0.420
	10	S203UP-K10	2CDS273317R0427	4016779616232	3	0.420
	13	S203UP-K13	2CDS273317R0447	4016779616249	3	0.420
	15	S203UP-K15	2CDS273317R0457	4016779616256	3	0.420
	16	S203UP-K16	2CDS273317R0467	4016779616263	3	0.420
	20	S203UP-K20	2CDS273317R0487	4016779616270	3	0.420
25	S203UP-K25	2CDS273317R0517	4016779616287	3	0.420	
4	0.2	S204UP-K0.2	2CDS274317R0087	4016779616355	2	0.560
	0.3	S204UP-K0.3	2CDS274317R0117	4016779616362	2	0.560
	0.5	S204UP-K0.5	2CDS274317R0157	4016779616379	2	0.560
	0.75	S204UP-K0.75	2CDS274317R0187	4016779616386	2	0.560
	1	S204UP-K1	2CDS274317R0217	4016779616393	2	0.560
	1.6	S204UP-K1.6	2CDS274317R0257	4016779616409	2	0.560
	2	S204UP-K2	2CDS274317R0277	4016779616416	2	0.560
	3	S204UP-K3	2CDS274317R0317	4016779616423	2	0.560
	4	S204UP-K4	2CDS274317R0337	4016779616430	2	0.560
	5	S204UP-K5	2CDS274317R0357	4016779616447	2	0.560
	6	S204UP-K6	2CDS274317R0377	4016779616454	2	0.560
	8	S204UP-K8	2CDS274317R0407	4016779616461	2	0.560
	10	S204UP-K10	2CDS274317R0427	4016779616478	2	0.560
	13	S204UP-K13	2CDS274317R0447	4016779616485	2	0.560
	15	S204UP-K15	2CDS274317R0457	4016779616492	2	0.560
	16	S204UP-K16	2CDS274317R0467	4016779616508	2	0.560
	20	S204UP-K20	2CDS274317R0487	4016779616515	2	0.560
25	S204UP-K25	2CDS274317R0517	4016779616522	2	0.560	

Miniature Circuit Breaker S 200 UP

Ordering data characteristic Z



2CDC0021318F0004

S 201 UP



2CDC0021319F0004

S 202 UP



2CDC0021320F0004

S 203 UP



2CDC0021321F0004

S 204 UP

Number of poles	Rated current I_n A	Type	Order code	bbn/EAN	Packing unit	Weight per PCE
					PCE	kg
1	0.5	S201UP-Z0.5	2CDS271317R0158	4016779616591	10	0.140
	1	S201UP-Z1	2CDS271317R0218	4016779616607	10	0.140
	1.6	S201UP-Z1.6	2CDS271317R0258	4016779616614	10	0.140
	2	S201UP-Z2	2CDS271317R0278	4016779616621	10	0.140
	3	S201UP-Z3	2CDS271317R0318	4016779616638	10	0.140
	4	S201UP-Z4	2CDS271317R0338	4016779616645	10	0.140
	5	S201UP-Z5	2CDS271317R0358	4016779616652	10	0.140
	6	S201UP-Z6	2CDS271317R0378	4016779616669	10	0.140
	8	S201UP-Z8	2CDS271317R0408	4016779616676	10	0.140
	10	S201UP-Z10	2CDS271317R0428	4016779616683	10	0.140
	13	S201UP-Z13	2CDS271317R0448	4016779616690	10	0.140
	15	S201UP-Z15	2CDS271317R0458	4016779616706	10	0.140
	16	S201UP-Z16	2CDS271317R0468	4016779616713	10	0.140
	20	S201UP-Z20	2CDS271317R0488	4016779616720	10	0.140
	25	S201UP-Z25	2CDS271317R0518	4016779616737	10	0.140
2	0.5	S202UP-Z0.5	2CDS272317R0158	4016779616805	5	0.280
	1	S202UP-Z1	2CDS272317R0218	4016779616812	5	0.280
	1.6	S202UP-Z1.6	2CDS272317R0258	4016779616829	5	0.280
	2	S202UP-Z2	2CDS272317R0278	4016779616836	5	0.280
	3	S202UP-Z3	2CDS272317R0318	4016779616843	5	0.280
	4	S202UP-Z4	2CDS272317R0338	4016779616850	5	0.280
	5	S202UP-Z5	2CDS272317R0358	4016779616867	5	0.280
	6	S202UP-Z6	2CDS272317R0378	4016779616874	5	0.280
	8	S202UP-Z8	2CDS272317R0408	4016779616881	5	0.280
	10	S202UP-Z10	2CDS272317R0428	4016779616898	5	0.280
	13	S202UP-Z13	2CDS272317R0448	4016779616904	5	0.280
	15	S202UP-Z15	2CDS272317R0458	4016779616911	5	0.280
	16	S202UP-Z16	2CDS272317R0468	4016779616928	5	0.280
	20	S202UP-Z20	2CDS272317R0488	4016779616935	5	0.280
	25	S202UP-Z25	2CDS272317R0518	4016779616942	5	0.280
3	0.5	S203UP-Z0.5	2CDS273317R0158	4016779617017	3	0.420
	1	S203UP-Z1	2CDS273317R0218	4016779617024	3	0.420
	1.6	S203UP-Z1.6	2CDS273317R0258	4016779617031	3	0.420
	2	S203UP-Z2	2CDS273317R0278	4016779617048	3	0.420
	3	S203UP-Z3	2CDS273317R0318	4016779617055	3	0.420
	4	S203UP-Z4	2CDS273317R0338	4016779617062	3	0.420
	5	S203UP-Z5	2CDS273317R0358	4016779617079	3	0.420
	6	S203UP-Z6	2CDS273317R0378	4016779617086	3	0.420
	8	S203UP-Z8	2CDS273317R0408	4016779617093	3	0.420
	10	S203UP-Z10	2CDS273317R0428	4016779617109	3	0.420
	13	S203UP-Z13	2CDS273317R0448	4016779617116	3	0.420
	15	S203UP-Z15	2CDS273317R0458	4016779617123	3	0.420
	16	S203UP-Z16	2CDS273317R0468	4016779617130	3	0.420
	20	S203UP-Z20	2CDS273317R0488	4016779617147	3	0.420
	25	S203UP-Z25	2CDS273317R0518	4016779617154	3	0.420
4	0.5	S204UP-Z0.5	2CDS274317R0158	4016779617222	2	0.560
	1	S204UP-Z1	2CDS274317R0218	4016779617239	2	0.560
	1.6	S204UP-Z1.6	2CDS274317R0258	4016779617246	2	0.560
	2	S204UP-Z2	2CDS274317R0278	4016779617253	2	0.560
	3	S204UP-Z3	2CDS274317R0318	4016779617260	2	0.560
	4	S204UP-Z4	2CDS274317R0338	4016779617277	2	0.560
	5	S204UP-Z5	2CDS274317R0358	4016779617284	2	0.560
	6	S204UP-Z6	2CDS274317R0378	4016779617291	2	0.560
	8	S204UP-Z8	2CDS274317R0408	4016779617307	2	0.560
	10	S204UP-Z10	2CDS274317R0428	4016779617314	2	0.560
	13	S204UP-Z13	2CDS274317R0448	4016779617321	2	0.560
	15	S204UP-Z15	2CDS274317R0458	4016779617338	2	0.560
	16	S204UP-Z16	2CDS274317R0468	4016779617345	2	0.560
	20	S204UP-Z20	2CDS274317R0488	4016779617352	2	0.560
	25	S204UP-Z25	2CDS274317R0518	4016779617369	2	0.560

Contact us

ABB STOTZ-KONTAKT GmbH

Eppelheimer Straße 82
69123 Heidelberg, Germany
Phone: +49 (0) 6221 7 01-0
Fax: +49 (0) 6221 7 01-13 25
E-Mail: info.desto@de.abb.com

You can find the address of your
local sales organization on the
ABB home page
<http://www.abb.com/contacts>
-> Low Voltage Products and Systems

Note:

We reserve the right to make technical changes or modify the contents of this document without prior notice. With regard to purchase orders, the agreed particulars shall prevail. ABB AG does not accept any responsibility whatsoever for potential errors or possible lack of information in this document.

We reserve all rights in this document and in the subject matter and illustrations contained therein. Any reproduction, disclosure to third parties or utilization of its contents – in whole or in parts – is forbidden without prior written consent of ABB AG.

Copyright© 2013 ABB
All rights reserved

Brochure number 2CDC002168D0202 (04/13-.pdf)